

Bang&Olufsen

This manual was scanned by
and available FREE at www.Iconic-AV.co.uk

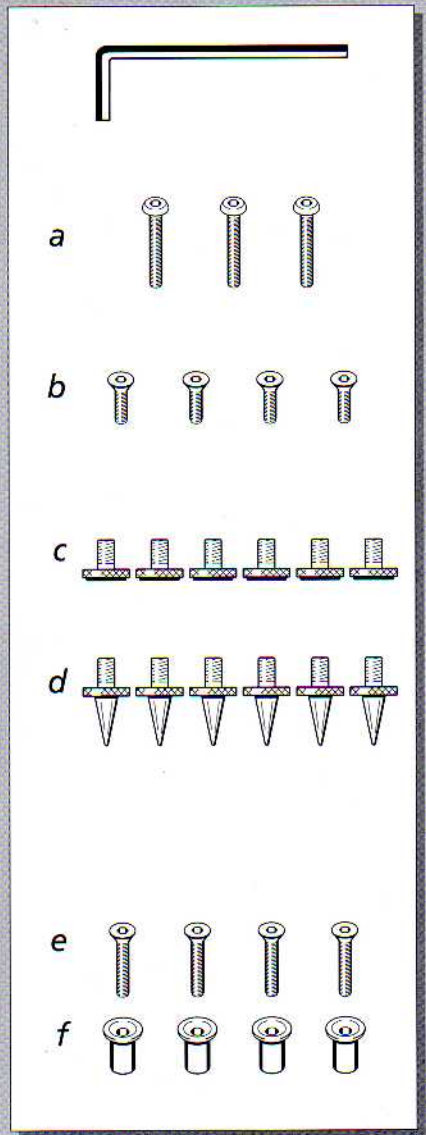

This manual was scanned by
and available FREE at www.lconic-AV.co.uk

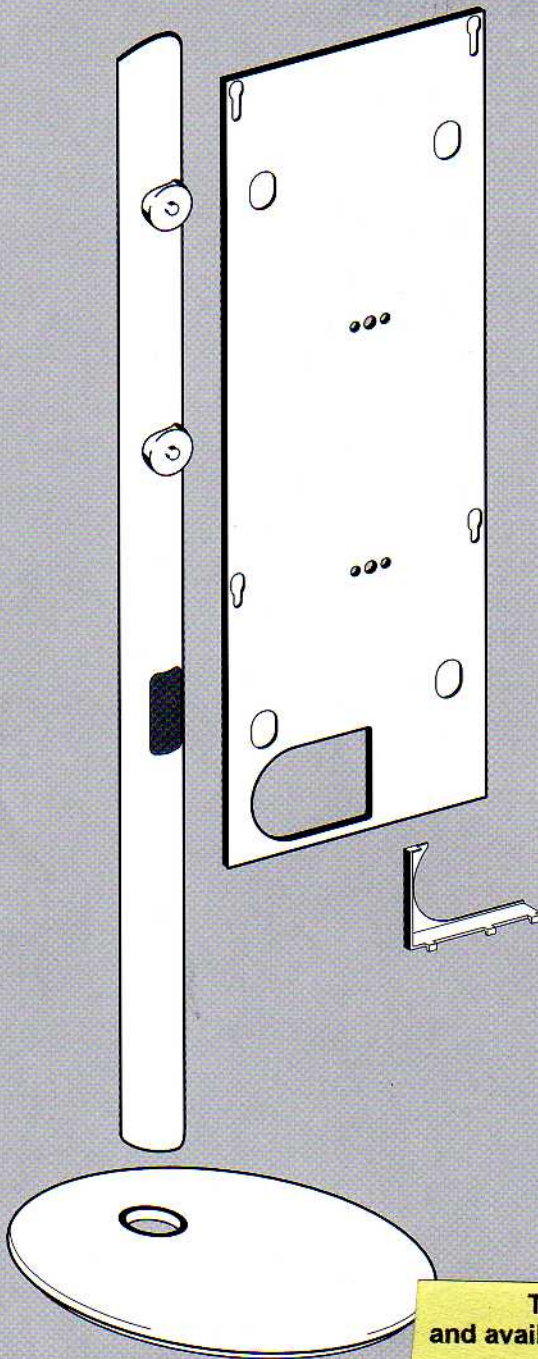
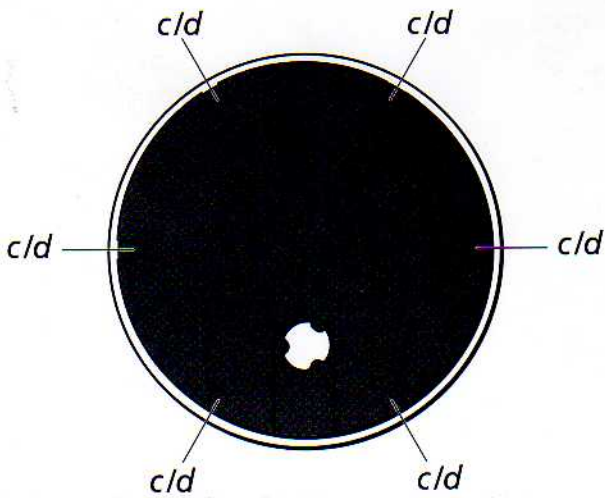
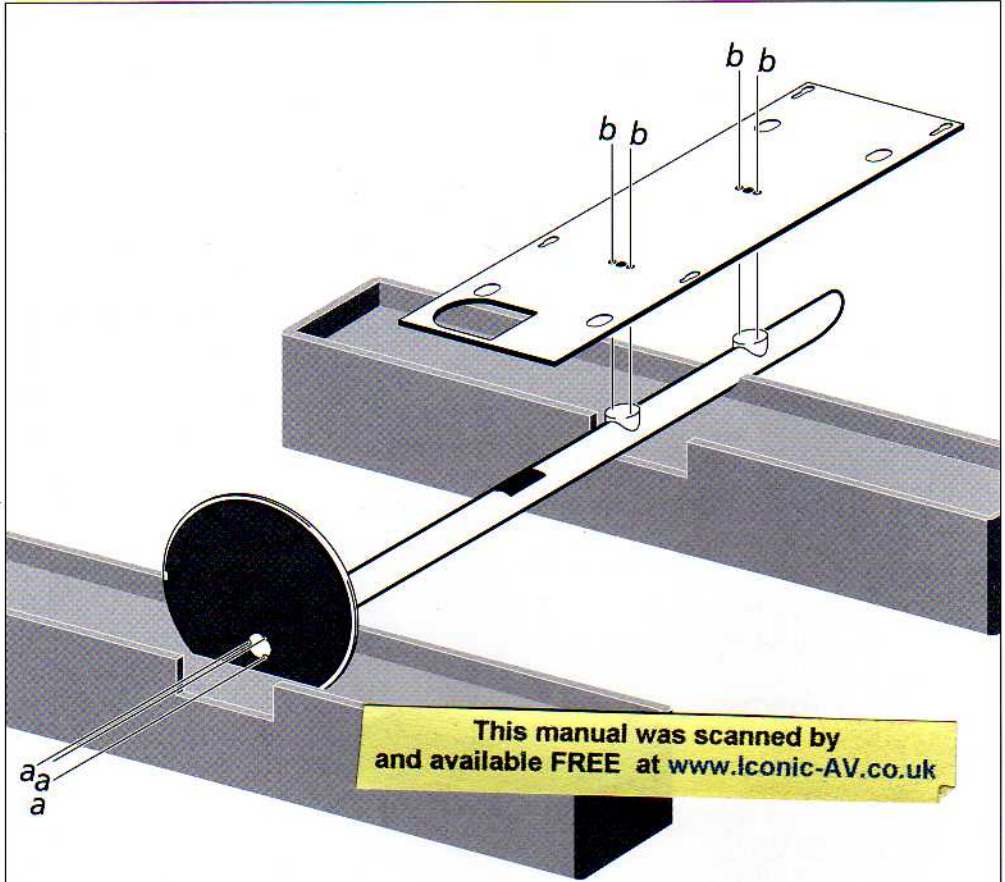

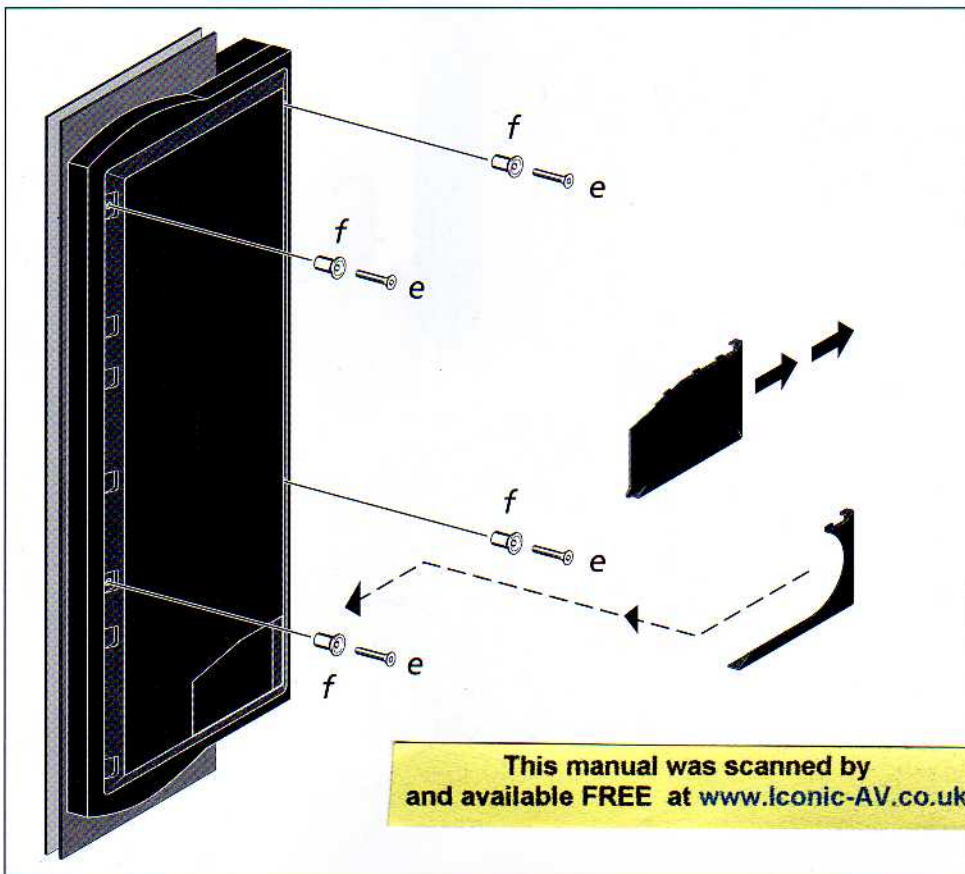
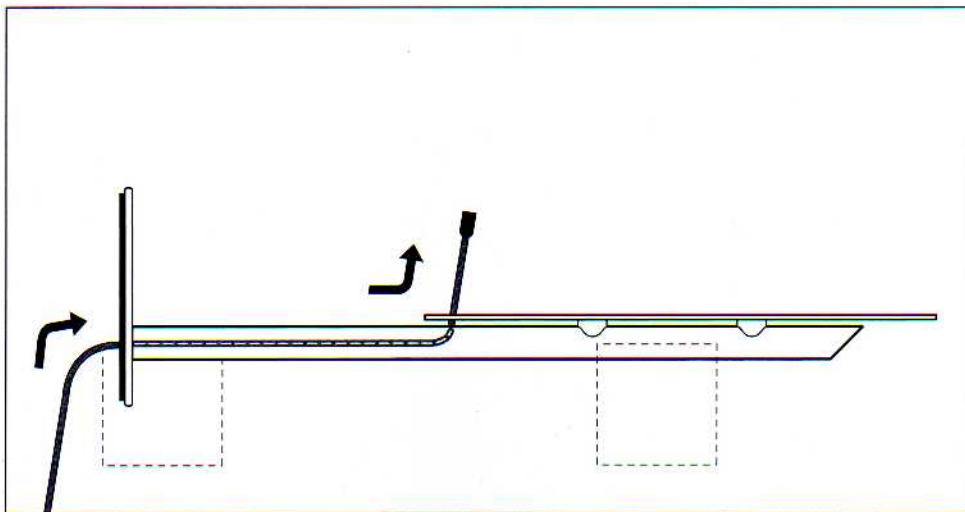

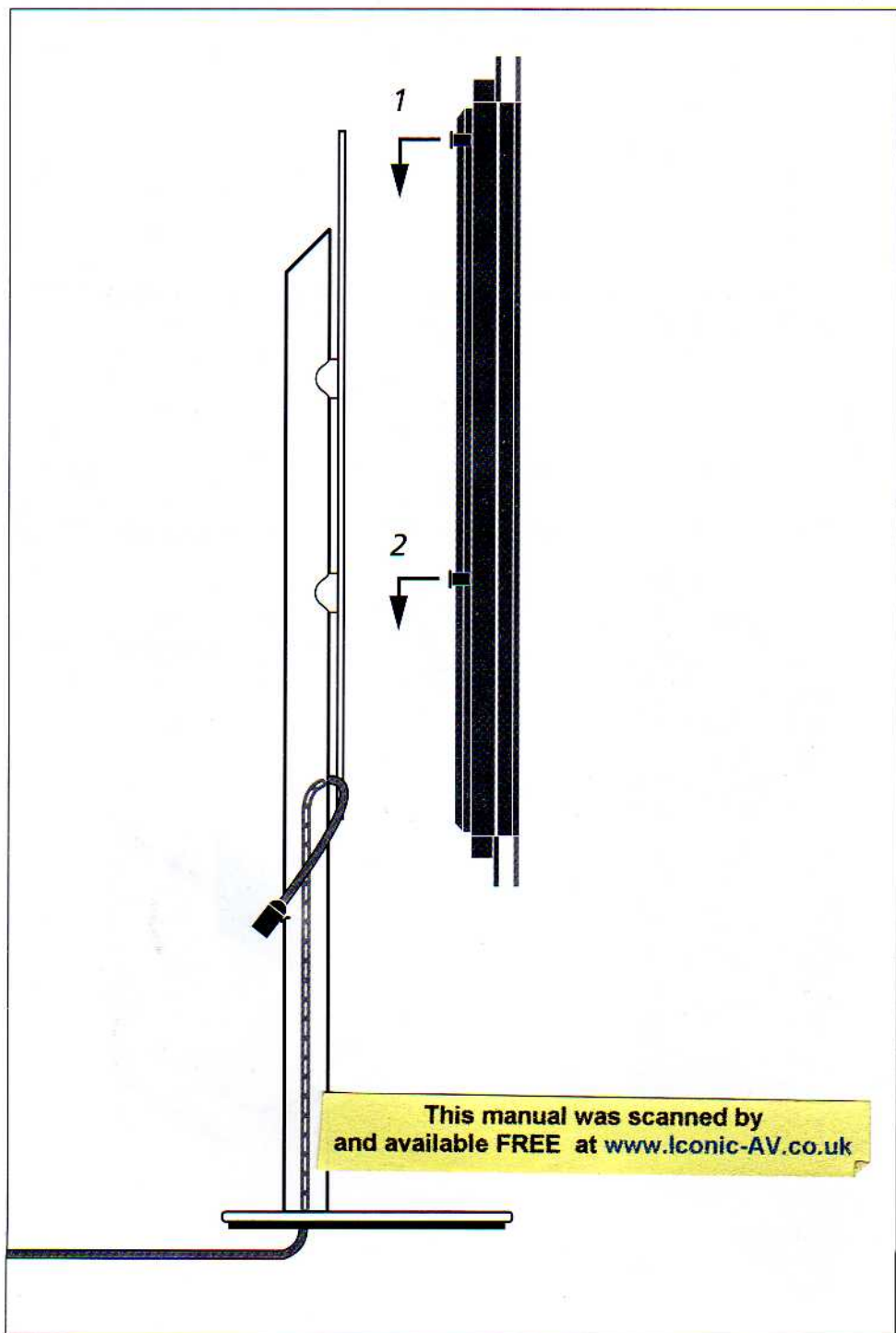

This manual was scanned by
and available FREE at www.Iconic-AV.co.uk

**This manual was scanned by
and available FREE at www.lconic-AV.co.uk**