

BeoVision 10-32

Guide

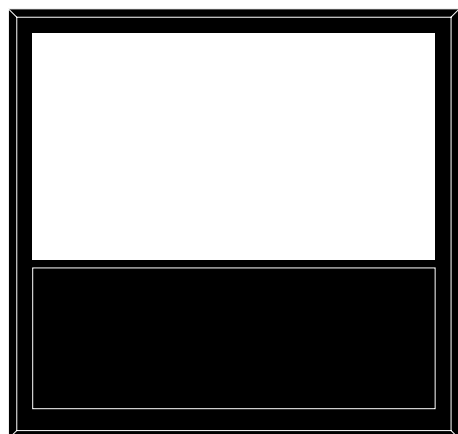

Contents

Menu overview, 3

See an overview of on-screen menus.

Navigate in menus, 4

See how to use the different remote controls for menu operation.

First-time setup, 5

Which menus appear when you switch on the television for the very first time.

Choose menu language, 6

How to select menu language.

Set positions for the television to turn to, 7

How to preset positions for a motorised stand to turn to.

Tuner setup, 8

How to disable the internal TV tuner or built-in DVB module.

Connections, 9

Examples of where to connect additional equipment and how to connect a PC.

Register additional video equipment, 12

How to register connected equipment in the CONNECTIONS menu.

Camera and headphones sockets, 15

How to watch digital pictures on your television and how to connect headphones.

Edit tuned TV channels, 16

How to rearrange the order in which channels appear in the channel list and how to name or delete them.

Re-tune or add channels, 19

How to add new channels or how to make a new automatic tuning.

Loudspeaker setup, 20

How to connect loudspeakers and adjust speaker balance.

Adjust picture and sound settings, 21

How to make settings for picture and how to adjust bass, treble, etc. How to use game mode.

Daily use of speaker combinations, 24

How to switch between different speaker combinations.

Set the television to switch itself on or off, 25

How to make your television switch off automatically or make it part of a Play Timer. How to make standby settings for your television.

Set up your Beo4 remote control, 27

Tell the television if your remote control has a navigation button or not.

Feature activation, 28

How to enter an activation key and get access to additional features.

HDMI MATRIX, 29

How to enter settings in the HDMI MATRIX menu.

Teletext, 31

How to store favourite teletext pages as MEMO pages.

Operate other equipment with Beo4 or Beo5, 32

How to operate connected equipment, such as set-top boxes, DVD players or the like, with the Bang & Olufsen remote control.

Connect and operate an audio system, 34

How to connect an audio system to your television and operate an integrated audio/video system.

Distribute sound and picture with BeoLink, 37

How to make link connections, operate a link system.

Your television in a link room, 39

How to set up and operate your television in a link room.

Two televisions in the same room, 41

Option programming and operation of two televisions in the same room.

Menu overview

1.

TUNING

SLEEP TIMER

PLAY TIMER

OPTIONS

2.

EDIT CHANNELS
ADD CHANNELS
AUTO TUNING
MANUAL TUNING

TIMER

CONNECTIONS

TUNER SETUP

SOUND

PICTURE

STAND POSITIONS

DTV PLAY TIMER

STANDBY SETTINGS

BEO4 SETTING

FEATURE ACTIVATION

MENU LANGUAGE

3.

FREQUENCY
CHANNEL NO
NAME
FINE TUNE
DECODER
TV SYSTEM
SOUND

AV1–AV6
HDMI EXPANDER
LINK TUNING

TV TUNER
DVB HD

ADJUSTMENT
SPEAKER TYPE

BRIGHTNESS
CONTRAST
COLOUR
TINT
SIZE
GAME MODE

VIDEO
AUDIO
STANDBY
STAND ADJUSTMENT

MODE
GROUP

AUTO STANDBY
POWER SAVING

NAVIGATION BUTTON
NO NAVIGATION BUTTON

Navigate in menus

Beo4 with navigation button

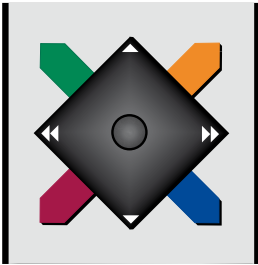

If you have a Beo4 remote control with navigation button and your television is set up for use with it, [see page 27](#), you use the centre button with up, down, left and right movement to navigate in menus. Press in the middle of the centre button to confirm selections and settings in menus.

Bring up the TV SETUP menu by pressing **MENU** while the TV is on. If you have selected a source which has a menu overlay, you must press **MENU** twice to bring up the TV SETUP menu.

To back up through menus, press **BACK**.
To exit menus, press and hold **BACK**.

If your television is set up for use without navigation button, you must use the 'star' to navigate up, down, left and right in menus and press the centre button to confirm selections and settings in menus. To back up through menus, press **STOP**. To exit menus, press **BACK**.

Beo4 without navigation button



If you have a Beo4 remote control without navigation button, you must use the 'star' to navigate up, down, left and right in menus and press the centre button to confirm choices and settings in menus. Also your television must be set up for use with a Beo4 without navigation button.

Bring up the TV SETUP menu by pressing **MENU** while the TV is on. If you have selected a source which has a menu overlay, you must press **MENU** twice to bring up the TV SETUP menu.

To back up through menus, press **STOP**.
To exit menus, press **EXIT**.

Beo5

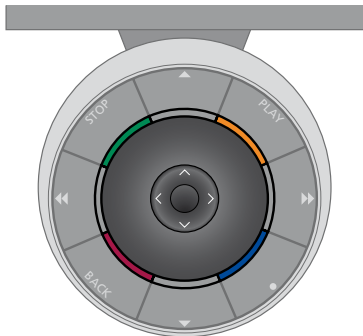

If you operate your television with the Beo5 remote control, you use the centre button with up, down, left and right movement to navigate in menus. Press in the middle of the centre button to confirm selections and settings in menus.

Bring up the TV SETUP menu by pressing **MENU** while the TV is on.

To back up through menus, press **BACK**.
To exit menus, press and hold **BACK**.

If your Beo5 is set up to be used without navigation button, press **STOP** to back up through menus and **BACK** to exit menus.

Note that a Beo5 should be re-configured when you add new products to your setup.

First-time setup

The setup procedure is activated when the television is connected to the mains and switched on for the first time. You are led through an automatic series of on-screen menus in which you must set up the TV and register the extra equipment you have connected, such as loudspeakers.

If you change your setup at a later date, you can access the same menus and update your settings.

The sequence of menus in first-time setup

MENU LANGUAGE ... You can select the language for on-screen menus. The text on the screen changes as you move from language to language.

STAND ADJUSTMENT ... Set the maximum angle for turn of the television. Use ◀ and ▶ to turn the television and limit the movement of the stand.

STAND POSITIONS ... Set your preferred preset positions for the television. For further information about the STAND POSITIONS menu, [see page 7](#).

TUNER SETUP ... Disable the television tuner or DVB tuner, if you like, [see page 8](#).

STANDBY SETTINGS ... The television can be set to switch itself to standby after some time with no operation. You can also switch Power Saving on or off, [see page 26](#).

CONNECTIONS ... Select the type of equipment you have connected to each socket group, the sockets used, the product name, and the source name. For further information about the CONNECTIONS menu, [see page 9](#).

CHECK AERIAL CONNECTION ... This prompt only appears, if the television tuner is enabled.

AUTO TUNING ... When you have registered your connected equipment, a menu for channel tuning automatically appears on the screen. Use the navigation button right to start auto tuning. The television finds all available channels. For further information about tuning TV channels, [see page 16](#).

SPEAKER TYPE ... Select which speakers are connected to the television, if any. [See page 20](#), for further information.

ADJUSTMENT ... Adjust bass, balance, volume, treble, etc.

DVB SETUP ... If the DVB tuner is enabled, the DVB SETUP menu appears, see the separate DVB Guide for further information.

For information about where to connect extra equipment, see the chapter about connection panels in [Getting Started](#).

Choose menu language

The menu language you choose during the first-time setup of your television can be changed at any time.

Once a menu language is chosen, all menus and display messages are shown in this language.

You can select the language for on-screen menus via the TV SETUP menu. The text on the screen changes as you move from language to language.

- > Bring up the TV SETUP menu and highlight OPTIONS.
- > Press the centre button to bring up the OPTIONS menu and highlight MENU LANGUAGE.
- > Press the centre button to bring up the MENU LANGUAGE menu.
- > Use the navigation button up or down to move to your language choice.
- > Press the centre button to make your choice.
- > Press **BACK** to back up through previous menus or press and hold **BACK** to leave the menus.

MENU LANGUAGE

DANSK
DEUTSCH
ENGLISH
ESPAÑOL
FRANÇAIS
ITALIANO
NEDERLANDS
SVENSKA

Set positions for the television to turn to

If your television is equipped with the optional motorised stand, you can turn it using the remote control.

Furthermore, you can program the television to turn automatically to face your favourite viewing position when you switch on the television. It can turn to a different position when you listen to, for example, a connected radio, and turn away to a standby position when you switch it off.

You can also turn your television by hand.

NOTE! For information about first-time installation of the motorised stand, see Getting Started.

Choose one position for when you switch the television on, one for audio mode, and one for when you switch it off.

- > Bring up the TV SETUP menu and highlight OPTIONS.
- > Press the centre button to bring up the OPTIONS menu and highlight STAND POSITIONS.
- > Press the centre button to bring up the STAND POSITIONS menu.
- > Press the centre button to determine the VIDEO position.
- > Use ◀ and ▶ to turn the television and place it according to your viewing position.
- > Press the centre button to store the position.

To store a stand position for when an audio source is switched on from the television ...

- > Highlight AUDIO.
- > Press the centre button to determine the AUDIO position.
- > Use ◀ and ▶ to turn the television and place it as you wish.
- > Press the centre button to store the position.

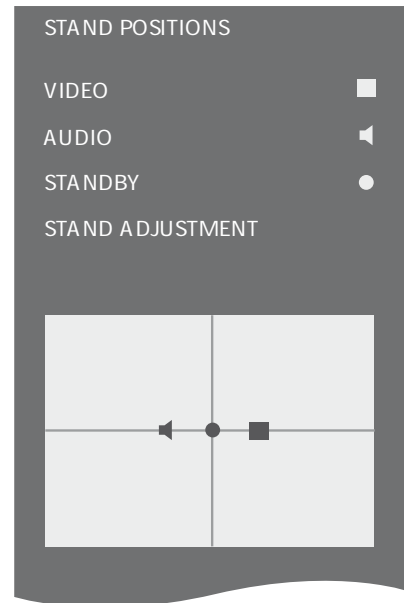

To store a stand position for when the television is switched to standby ...

- > Highlight STANDBY.
- > Press the centre button to determine the STANDBY position.
- > Use ◀ and ▶ to turn the television and place it as you wish.
- > Press the centre button to store the position.
- > During first-time setup, press the green button to continue first time-setup, otherwise ...
- > ... press and hold BACK to leave all menus.

Tuner setup

If you disable the TV tuner, you can activate the optional DVB tuner with the TV button. If you disable the DVB tuner, you can activate a connected peripheral unit with the DTV button.

To disable the internal tuner ...

- > Bring up the TV SETUP menu and highlight OPTIONS.
- > Press the centre button to bring up the OPTIONS menu, and highlight TUNER SETUP.
- > Press the centre button to bring up the TUNER SETUP menu and highlight TV TUNER.
- > Use the navigation button left or right to switch between the setting ON or OFF.
- > Highlight DVB HD.
- > Use the navigation button left or right to switch between the setting ON or OFF.
- > Press the centre button to store the settings, or ...
- > ... press and hold BACK to leave the menus without storing.

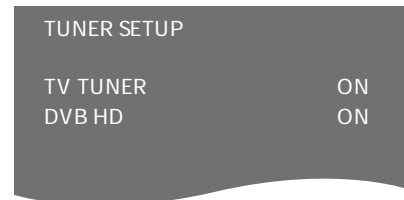

The TUNING menu is only available if the TV tuner is enabled.

If you have connected a Bang & Olufsen hard disk recorder to your TV, we recommend not to disable the TV tuner.

Connections

The connection panel on your television allows you to connect signal input cables as well as a variety of extra equipment, such as a recorder or a linked Bang & Olufsen music system.

Any equipment you connect to these sockets must be registered in the CONNECTIONS menu. For further information, [see page 12](#).

Before you connect any equipment to your television, remember to disconnect the television from the mains.

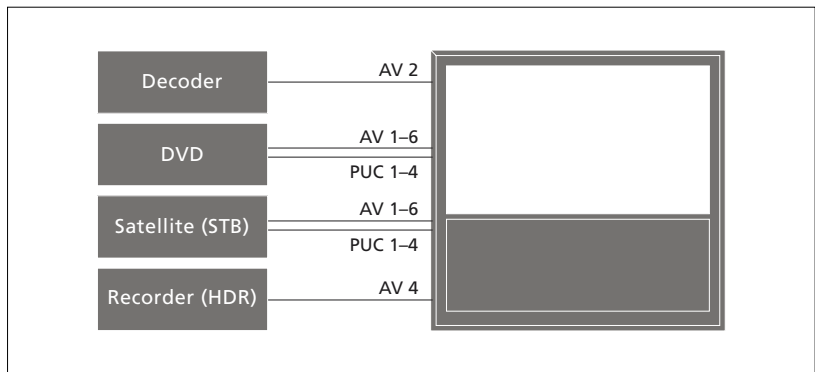
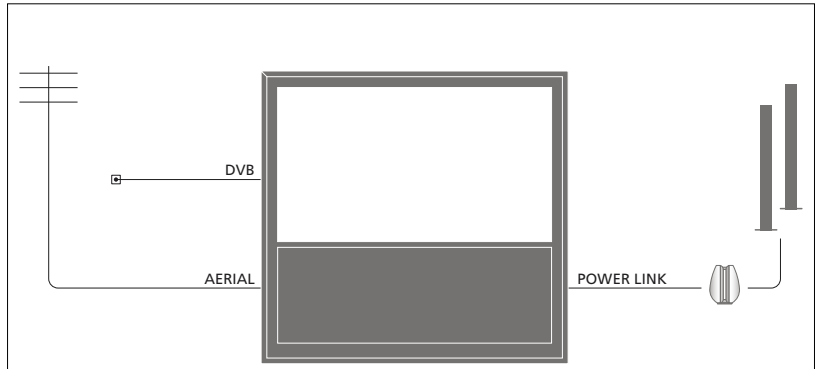

There are some restrictions as to the types of equipment that can be connected to the sockets.

If you have a Bang & Olufsen HDR1 or HDR2, it must be connected and registered to the AV4 socket.

Equipment with VGA output can only be connected and registered to the AV3 socket.

IR type

In the AV menus you can select how a PUC controlled product is connected. You can choose between 'PLUG' (cable) and 'IR' (IR Blaster).

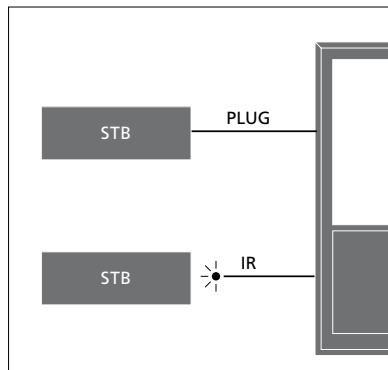

IR-transmitters To operate non-Bang & Olufsen products with a Bang & Olufsen remote control, attach a Bang & Olufsen IR-transmitter to each of the products. Connect each transmitter to one of the sockets marked PUC on the main connection panel.

DVB module

The CA module is a 'card reader' for your Smart Card which decodes the coded signals sent out by the programme provider.

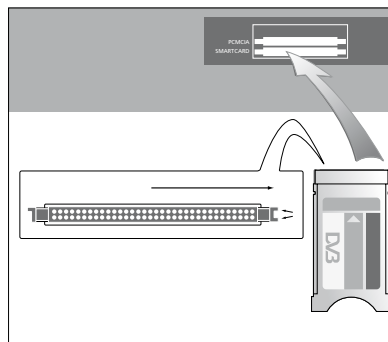

Insert the Smart Card in the CA module with the chip facing towards the television. The CA module has one protruding edge on one side and two protruding edges on the other side. The side with one edge should face upwards. The Conax Smart Card must be inserted with the chip facing away from the television front.

>> Connections

Connect and use a PC

IMPORTANT! Before connecting a PC to the television, disconnect the television, the computer, and all equipment connected to the computer from the mains.

To connect a computer to the television ...

- > Using the appropriate type of cable, connect one end to the DVI, VGA or HDMI output socket on your computer, and the other end to the VGA or HDMI socket on the television.
- > To hear sound from the computer in the speakers connected to the television, use the appropriate cable and connect the sound output on the computer to the R-L or SPDIF sockets on the television when appropriate.
- > Reconnect the television, the computer, and all equipment connected to the computer to the mains. Remember, the computer must be connected to a grounded wall outlet as specified in its setting-up instructions.

If you have connected your PC to the VGA socket on the television, you must register the PC to the AV3 socket in the CONNECTIONS menu. A PC connected to the HDMI socket can be registered to any of the AV sockets or socket groups.

Bring up the computer image on the screen

To see the computer picture on the screen, you must bring it up with your remote control.

To bring up the computer picture ...

- > Press LIST and use the navigation button up or down to bring up PC in the Beo4 display and press the centre button to bring up the picture. You can then operate the computer as you normally would. (Beo5: Press Pc).

Register additional video equipment

If you connect additional video equipment to your television, you must register the equipment in the CONNECTIONS menu.

The CONNECTIONS menu appears automatically on the screen during first-time setup for you to register connected equipment, if it is not detected automatically by the television. If you connect equipment at a later date, you must register this equipment in the CONNECTIONS menu.

What is connected?

Registering the equipment connected to the television enables you to operate it with your remote control.

- > Bring up the TV SETUP menu and highlight OPTIONS.
- > Press the **centre** button to bring up the OPTIONS menu. CONNECTIONS is highlighted already.
- > Press the **centre** button to bring up the CONNECTIONS menu.
- > Use the navigation button up or down to step between the different socket groups: AV1, AV2, AV3, AV4, AV5, AV6 and HDMI EXPANDER, HDMI MATRIX when available. For information about LINK TUNING [see page 38](#).
- > Press the **centre** button to be able to register a connected product type to the highlighted socket group.
- > Use the navigation button up and down to move between the sockets in the group.
- > Use the navigation button left or right to register what you have connected to the highlighted socket.
- > Press the **centre** button to be able to select the product from an on-screen list.
- > Use the navigation button left or right to see lists for other types of products.
- > Use the navigation button up or down or a number button to highlight the name of the product and press the **centre** button to register it.
- > Press the **green** button to be able to name the source. The naming menu is now activated.
- > Use the navigation button up and down to find the individual characters in the name.
- > Press the **centre** button to accept the name.

CONNECTIONS

AV1	NONE
AV2	NONE
AV3	NONE
AV4	NONE
AV5	CAMERA
AV6	NONE
HDMI EXPANDER	NO
HDMI MATRIX	NO
LINK TUNING	NO

The available sockets may vary according to your setup.

- > Names are shown in the television on-screen display when the source is selected.
- > Press the **centre** button to bring up the STANDBY OPTIONS menu.
- > Use the navigation button up or down to see the list of standby options for when the connected equipment should switch to standby.
- > Press the **centre** button to select a standby option.
- > When you have completed your settings for a single socket group, press the **centre** button to return to the CONNECTIONS menu.
- > Repeat the procedure for each socket group.

*At first-time setup only, when you have registered all connected equipment, press the **green** button to store the setup.*

What's on the AV1 – AV6 menu ...

SOURCE ... Select the source you have connected. The option you select indicates which remote control button switches on the source. For example, a source registered as V.MEM is switched on when you press the V.MEM button. A source registered as DTV2 is switched on by pressing LIST and then the navigation button up or down to display DTV2 and press the centre button. (Beo5: Press DTV2). Options are:

NONE ... if nothing is connected.

V.MEM ... for a connected video recorder or hard disk recorder.

DVD/DVD2 ... for a connected DVD player or recorder.

DTV2 ... for other equipment, such as a set-top box.

DTV ... occupied by the DVB module, unless you disable the DVB module.

V.AUX2 ... for other equipment, such as a video game console.

TV ... occupied by the TV tuner, unless you disable both tuners in the TUNER SETUP menu.

PC ... for a connected PC.

DECODER ... for a connected decoder.

The source lists are divided into 4 groups; 'stb' are set-top boxes, 'dvd' are DVD players and recorders, 'vmem' are video recorders including hard disk recorders, 'other' are, for example, PCs and media centres.

NAME ... Allows you to name the source you are registering, the name you enter appears in the on-screen display when you activate the source.

(AUTO SELECTION) ... Allows a source connected to AV5 to be selected automatically as soon as the television detects a signal, provided the television is on at the time. Options are ON and OFF.

IR SOCKET ... Select which IR socket is used for the source, options are PUC1, PUC2, PUC3, PUC4 and NONE.

IR TYPE ... Select the type of IR connection used. Options are PLUG (for a cable connection) and IR (for an IR blaster connection). If you select PLUG you need to select if MODULATION must be set to ON or OFF.

HDMI ... Indicates whether or not the equipment is connected to the television via one of the HDMI sockets. Select the appropriate socket: A, B, or C.

(YPbPr) ... Indicates whether or not the equipment is connected to the television via the YPbPr sockets. Options are YES and NO. Can only be registered in one of the AV menus (AV2-AV4 or AV6) at any time.

(VGA) ... Indicates whether or not the equipment is connected to the television via the VGA socket. Options are YES and NO.

S/P-DIF ... Select the S/P-DIF connection used. Options are 1, 2 and NONE.

An HDMI Expander must always be connected to HDMI C. When connecting an HDMI Expander, additional HDMI sockets become available; C1, C2, C3 and C4.

While it is possible to register equipment under any of the available source types, the type you select affects how you can use your source.

AV2

SOURCE	NONE
NAME
IR SOCKET	NONE
IR TYPE	IR
HDMI	NONE
Y/Pb/Pr	NO
S/P-DIF	NONE

Regarding High Definition (HD)

sources ...

Standard Definition (SD) signals can be recorded, as well as distributed to a link room television, but HD signals cannot.

Connect both the HD and the SD signals to the television. The best signal is always used. If no HD signal is available, the SD signal is shown.

Standby options ...

When you register a non-Bang & Olufsen product in the CONNECTIONS menu, you can also select different 'STANDBY OPTIONS' for your product. This means that you can select if the connected product should switch to standby automatically.

The options are:

OFF AT SOURCE CHANGE ... The product switches to standby immediately when you select another source.

OFF AT TV STANDBY ... The product switches to standby when you switch the television to standby.

ALWAYS ON ... The product does not switch to standby automatically.

MANUAL CONTROL ... The product can be switched on and off by means of the remote control.

Camera and headphones sockets

You can connect headphones and listen to a programme, or you can connect a Camcorder and watch your home movies on the television.

Remove the cover to access the camera and headphones sockets. To remove the cover, press at the right or left side of the cover and you can easily flip it off.

Sockets for temporary connections

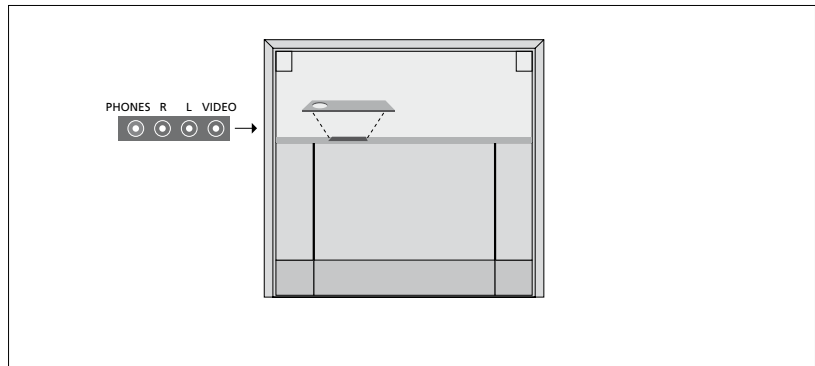

PHONES

You can connect stereo headphones to the socket marked PHONES.

- When the sound in the speakers is not muted, volume adjustment is directed at the speakers.
- To mute the speakers connected to the television, press the middle of the $\wedge \vee$ button.
- When sound is muted in the speakers, press \wedge or \vee to adjust sound in headphones.
- To restore sound in the speakers, press the middle of the $\wedge \vee$ button.

Note: Prolonged listening at high volume levels can cause hearing damage!

R - L

For audio connection (right and left sound channel respectively).

VIDEO

For connection of the video signal.

Watch digital pictures on your television

To watch your camera pictures, connect the camera to the AV5 socket(s) and switch the television on. The television automatically registers the signal and you can see the still pictures on the screen.

To select the CAMERA input via Beo4 ...

> Press LIST repeatedly to display CAMERA* on Beo4 and press the centre button. (Beo5: Press Camera).

**In order to display CAMERA on Beo4, you must first add it to the Beo4 list of functions. For further information, see the Guide enclosed with Beo4.*

Edit tuned TV channels

If automatic tuning of all channels has not stored the channels on your preferred channel numbers or has not named all the stored channels automatically, you can rearrange the order in which the channels appear and provide them with a name of your own choice.

If the tuned channels require additional editing, such as fine tuning, use the MANUAL TUNING menu, [see page 18](#).

For tuning of digital channel, see the Guide for your DVB module.

Move, name or delete tuned TV channels

Once automatic tuning of channels has been completed, the EDIT CHANNELS menu appears automatically and you can move or name the TV channels that have been tuned in. You can also delete any tuned TV channel you do not want.

Enter the EDIT CHANNELS menu ...

- > Bring up the TV SETUP menu and highlight TUNING.
- > Press the centre button to bring up the TUNING menu and highlight EDIT CHANNELS.
- > Press the centre button to bring up the EDIT CHANNELS menu.

Move tuned TV channels ...

- > In the EDIT CHANNELS menu, highlight the channel you wish to move.
- > Use the navigation button right to move the channel out of the list.
- > Use the navigation button up or down to move the channel to the desired channel number.
- > Use the navigation button left to move the channel back into the list or change places with the channel which occupies the desired channel number.
- > Now, move the channel with which you have changed places to an empty channel number or to a number already occupied and repeat the procedure.
- > When you have moved the relevant channels, press BACK to back up through menus, or press and hold BACK to exit all menus.

>> *Edit tuned TV channels*

Name tuned channels ...

- > In the EDIT CHANNELS menu highlight the channel you wish to name.
- > Press the **green** button to be able to name the channel. The naming menu is now activated.
- > Use the navigation button up and down to find the individual characters in the name.
- > Move between character places with the navigation button left and right.
- > Press the **centre** button to store the name.
- > If necessary, repeat the procedure and name other channel numbers.
- > When you have named the relevant channels, press the **centre** button to accept your edited list, or press and hold **BACK** to exit all menus without storing.

Delete tuned channels ...

- > In the EDIT CHANNELS menu highlight the channel you wish to delete.
- > Use the navigation button right to move the channel out of the list.
- > Press the **yellow** button to be able to delete the channel.
- > Press the **yellow** button again to confirm the deletion, or press the navigation button left twice to move the channel back into the list.
- > When you have deleted the relevant channels, press and hold **BACK** to exit all menus.



Move a channel.



Name a channel.



Delete a channel.

Adjust tuned channels

You can store TV channels on channel numbers of their own. Fine tune the channel reception, indicate the presence of coded channels and choose appropriate sound types for the individual channels.

- > Bring up the TV SETUP menu and highlight TUNING.
- > Press the **centre** button to bring up the TUNING menu and highlight MANUAL TUNING.
- > Press the **centre** button to bring up the MANUAL TUNING menu.
- > Use the navigation button up and down to move between the items in the menu.
- > Use the navigation button left and right to view your choices for each item.
- > If you choose NAME, then press the **green** button to start the naming procedure. Use the navigation button up and down to enter the characters in the name you choose. Use the navigation button left and right to move between the characters in the name.
- > When you have finished editing, press the **centre** button to accept the settings.
- > Press the **centre** button to store the adjusted channel.
- > Press and hold **BACK** to exit all menus.

If the item SYSTEM appears on the menu, then make sure that the correct broadcast system is displayed before you begin tuning.

If channels are broadcasted with two languages and you want both languages, you can store the channel twice, once with each language.

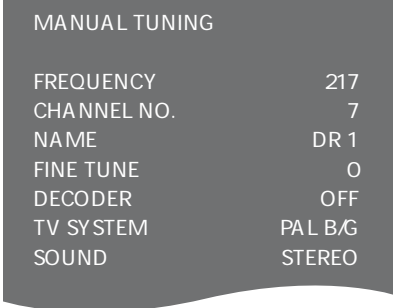

MANUAL TUNING	
FREQUENCY	217
CHANNEL NO.	7
NAME	DR 1
FINE TUNE	0
DECODER	OFF
TV SYSTEM	PAL B/G
SOUND	STEREO

Even though you store a type of sound/ language, you can switch between the various types while watching a TV programme.

Re-tune or add channels

You can make your television find your TV channels for you.

Preset up to 99 different TV channels on channel numbers of their own and give each channel a distinct name.

You can tune in new channels, for example, if you move – or re-tune, previously deleted channels.

When tuning in channels via the ADD CHANNELS menu, your previously tuned channels are left unchanged. This allows you to keep channel names, their order in the TV list, and any special settings you may have stored for those channels.

You can re-tune all your TV channels by letting the television tune in all the channels automatically. You can also add a new channel or update a tuned channel which, for example, has been moved by the broadcaster.

- > Bring up the TV SETUP menu and highlight TUNING.
- > Press the centre button to bring up the TUNING menu.

Re-tune via automatic tuning ...

- > In the TUNING menu highlight AUTO TUNING.
- > Press the centre button to bring up the AUTO TUNING menu.
- > Use the navigation button right to start auto tuning.
- > Once auto tuning is completed, the EDIT CHANNELS menu appears. You can then remove or name channels.

Add new TV channels ...

- > In the TUNING menu highlight ADD CHANNELS.
- > Press the centre button to bring up the ADD CHANNELS menu.
- > Use the navigation button right to start. New channels are added automatically as they are found.
- > When tuning is completed and new channels have been added, the EDIT CHANNELS menu appears. You can then remove or name channels. The cursor highlights the first new channel just added to the list.



NOTE! If you re-tune all your TV channels, all the channel settings you have made disappear!

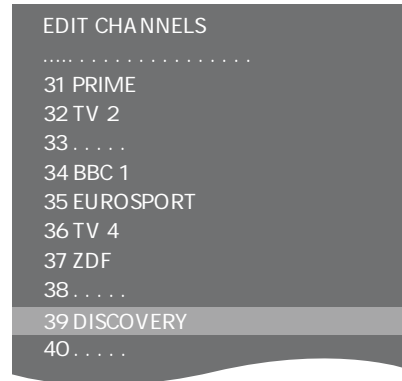

Loudspeaker setup

If you want, you can connect Power Link speakers and a BeoLab subwoofer to your television. You can also choose to connect only a subwoofer or a set of external speakers.

If you connect both speakers and a subwoofer, the subwoofer must be connected to the television and the speakers must be connected to the subwoofer.

Select your speaker type

Switch on the television before you adjust speaker settings.

To register the speaker types ...

- > Bring up the TV SETUP menu and highlight OPTIONS.
- > Press the centre button to bring up the OPTIONS menu and highlight SOUND.
- > Press the centre button to bring up the SOUND menu and highlight SPEAKER TYPE.
- > Press the centre button to bring up the SPEAKER TYPE menu and use the navigation button up or down to select your speaker type.
- > Use the navigation button left or right to switch between YES or NO.
- > Press the centre button to store or press BACK to leave the menu without storing.

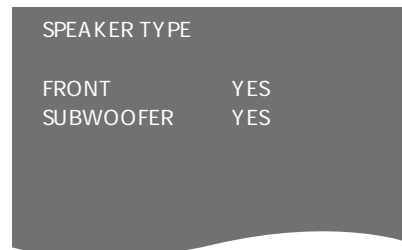

Adjust picture and sound settings

Picture and sound settings are preset from the factory to neutral values which suit most viewing and listening situations. However, if you wish, you can adjust these settings to your liking.

Adjust picture brightness, contrast or colour. Sound settings include volume, balance, bass, and treble.

Store your picture and sound settings temporarily – until your television is switched off – or store them permanently.

Activate GAME MODE if you connect a game console to your television.

For information about how to change the picture format, see Getting Started.

Adjust brightness, colour or contrast

Adjust the picture settings via the PICTURE menu. Temporary settings are cancelled when you switch off the television.

- > Bring up the TV SETUP menu and highlight OPTIONS.
- > Press the centre button to bring up the OPTIONS menu and highlight PICTURE.
- > Press the centre button to bring up the PICTURE menu.
- > Use the navigation button up or down to move through menu items.
- > Use the navigation button left or right to adjust the values.
- > Press BACK to store your settings until you switch off the television, or
- > ... press the centre button to store your settings permanently.

For video sources using the VGA signal, the following options appear as well:

- HOR. SIZE ... Adjusts the picture size along the horizontal axis.
- VERT. SIZE ... Adjusts the picture size along the vertical axis.
- HOR. POSITION ... Adjusts the picture position along the horizontal axis.
- VERT. POSITION ... Adjusts the picture position along the vertical axis.

Note that these four settings only apply for the screen resolution in effect at the time you adjust the settings.

To temporarily remove the picture from the screen, press LIST and use the navigation button up or down to bring up P.MUTE in the Beo4 display and press the centre button. To restore the picture, press a source button. (Beo5: Press Δ to bring up the Scene display on Beo5, press Picture, then press P.Mute. To restore the picture, press P.Mute again).

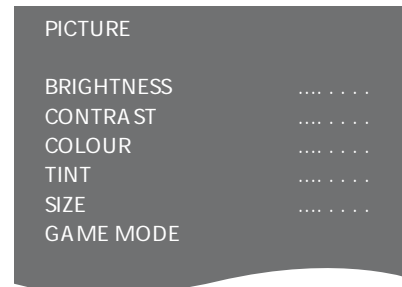

When signals are sent in format 720p, 1080p or 1080i, the menu item SIZE is available in the PICTURE menu.

Game mode

If you connect a game console or play a PC game using the television as a monitor, you can activate 'Game mode'. Game mode minimises the delay caused by signal processing. Game mode is automatically deactivated when you change source or switch to standby.

To activate GAME MODE with Beo5 directly ...

- > Press Game to activate GAME MODE, press again to deactivate GAME MODE.

To use GAME MODE ...

- > Bring up the TV SETUP menu and highlight OPTIONS.
- > Press the centre button to bring up the OPTIONS menu and highlight PICTURE.
- > Press the centre button to bring up the PICTURE menu.
- > Use the navigation button up or down to move to GAME MODE.
- > Press the centre button repeatedly to switch between ON and OFF.

To activate GAME MODE with Beo4 directly ...

- > Press LIST and use the navigation button up or down to bring up GAME in the Beo4 display.
- > Press the centre button repeatedly to switch between ON and OFF.

Adjust volume, balance, bass or treble

You can preset levels for sound volume, balance, bass, treble and a subwoofer.

You can switch the loudness feature on or off. The loudness feature compensates for the human ear's lack of sensitivity to high and low frequencies. These frequencies are boosted at low volume levels so that low music becomes more dynamic.

If you have connected external speakers, you can preset two default speaker combinations; one to be used each time you switch on a video source in your television, and one to be used each time you switch on an audio source connected to your television. You can still select a different speaker combination any time you wish.

For further information about speaker combinations, [see page 24](#).

To adjust sound ...

- > Bring up the TV SETUP menu and highlight OPTIONS.
- > Press the centre button to bring up the OPTIONS menu and highlight SOUND.
- > Press the centre button to bring up the SOUND menu, and highlight ADJUSTMENT.
- > Press the centre button to bring up the ADJUSTMENT menu.
- > Use the navigation button up or down to select an item to adjust.
- > Use the navigation button left or right to adjust the values or choose a setting.
- > Press BACK to store your settings until you switch off your television, or ...
- > ... press the centre button to store your settings permanently.

ADJUSTMENT	
VOLUME
* BALANCE
BASS
TREBLE
SUBWOOFER
LOUDNESS	ON
DEFAULT VIDEO	SPEAKER3
DEFAULT AUDIO	SPEAKER2

ADJUSTMENT	
VOLUME
* BALANCE
BASS
TREBLE
CENTRE
LOUDNESS	ON
DEFAULT VIDEO	SPEAKER3
DEFAULT AUDIO	SPEAKER2

The content of the ADJUSTMENT menu varies according to what you have connected to the television.

The subwoofer menu is only available if a subwoofer is connected and no external speakers are connected. If external speakers are connected and you have selected SPEAKER3, the CENTRE menu is available. Here you can adjust the balance between internal speakers and the external connected speakers.

**BALANCE adjusts the left/right balance between the speakers. To adjust the balance temporarily, [see page 24](#).*

Daily use of speaker combinations

You can select the speaker combination that suits the source you are using, provided that the various speaker modes are available in your television.

NOTE! If you have no external speakers connected or only a subwoofer, you will only be able to choose **SPEAKER 1**.

Select speakers for movie sound

You can choose between three speaker modes depending on which source you are using and which speakers you have connected to your television.

- > Press **LIST** and use the navigation button up or down to bring up **SPEAKER** in the Beo4 display (Beo5: Press \triangle to bring up the Scene display on Beo5, then press **Speaker** to bring up the Speaker display).
- > Press **1 – 3** to select the speaker combination you want. (Beo5: Press **Optimise** or **Mode 1 – 3**). The selected speakers cut in automatically.
- > Press and hold **BACK** to remove **SPEAKER** from the Beo4 display and return to the source you were using. (Beo5: Press \triangle to remove the Speaker display).

Adjust speaker balance with Beo4

You can temporarily adjust the balance between the speakers ...

- > Press **LIST** and use the navigation button up or down to bring up **SPEAKER** in the Beo4 display and press the centre button.
- > Now use **◀** and **▶** to adjust the speaker balance left and right.
- > Press **BACK** to remove **SPEAKER** from the Beo4 display and return to the source you were using.

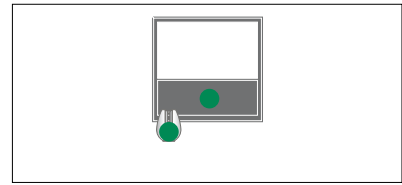

SPEAKER 1

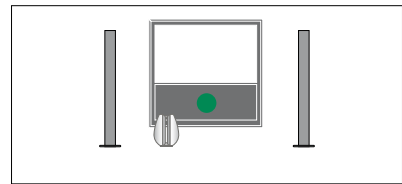

SPEAKER 1

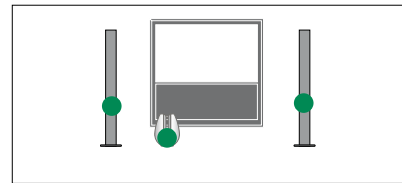

SPEAKER 2

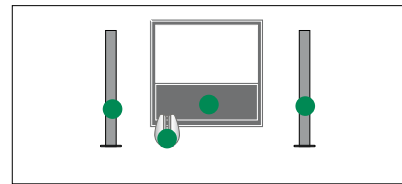

SPEAKER 3

You can preset two default speaker combinations which suit the source you are using, [see page 23](#).

Set the television to switch itself on or off

Your television has a built in Sleep Timer which means that you can make it switch off after a designated number of minutes.

Also you can make the television react to a Play Timer programmed on an Audio or Video Master connected to the television via Master Link.

If the Play Timer source is DTV, settings must be made in the DTV PLAY TIMER menu.

NOTE! For safety reasons, the stand will not turn if the TV is switched on by a Play Timer.

Sleep Timer

You can make the television switch off automatically after a number of minutes

To activate the Sleep Timer with Beo4 ...

- > Press LIST and use the navigation button up or down to bring up SLEEP in the Beo4 display.
- > Press the centre button repeatedly to select the number of minutes.

To deactivate the Sleep Timer with Beo4 ...

- > Press LIST and use the navigation button up or down to bring up SLEEP in the Beo4 display.
- > Press the centre button repeatedly until OFF is shown on the television screen.

To activate or deactivate the Sleep Timer with Beo5 ...

- > Press Sleep and select the number of minutes or Off.

To set the Sleep Timer via the menu ...

- > Bring up the TV SETUP menu and highlight SLEEP TIMER.
- > Press the centre button to bring up the SLEEP TIMER menu.
- > Press the centre button repeatedly to switch between the number of minutes and OFF.

Play Timer

If you connect a Bang & Olufsen audio or video product to your television with a Master Link cable, you can exclude or include it in timed functions via the PLAY TIMER menu. For example, set the television Play Timer to ON and an audio system's Play Timer to OFF if you wish timed functions to apply only to the television.

To switch on the Play Timer ...

- > Bring up the TV SETUP menu and highlight PLAY TIMER.
- > Press the centre button to bring up the PLAY TIMER menu, and highlight TIMER ON/OFF.
- > Press the centre button to bring up the TIMER ON/OFF menu.
- > Use the navigation button left or right to reveal ON.
- > Press the centre button to store the setting.

For further information about how to program Timers and switch the Play Timer on or off for a connected Bang & Olufsen audio or video product, see the Guide enclosed with the product.

DTV Play Timer

You can program a Play Timer on a connected Bang & Olufsen audio or video product. If the Play Timer uses the DVB Module in the television as source, you must tell it which MODE it should start in. That is should radio or television switch on. Also you must tell it which GROUP, that is which of the station or channel groups should be used when the Play Timer is executed.

To make settings for a DTV Play Timer ...

- > Bring up the TV SETUP menu and highlight OPTIONS.
- > Press the centre button to bring up the OPTIONS menu and highlight DTV PLAY TIMER.
- > Press the centre button to bring up the DTV PLAY TIMER menu, and use the navigation button up or down to move between MODE and GROUP.
- > Use the navigation button left or right to select the setting you want.
- > Press the centre button to store the setting.
- > Press BACK to back up through previous menus or press and hold BACK to exit all menus.

Note! If the TV tuner is disabled and the DVB module is activated by pressing TV on the remote control, the name of the menu is TV PLAY TIMER.

Also remember to set the PLAY TIMER menu to ON, if the television or its speakers are to be activated by the Play Timer.

Standby Settings

The television can be set to switch itself to standby after some time with no operation. The factory setting is 4 hours. This function only applies in video mode not in audio mode.

To make standby settings ...

- > Bring up the TV SETUP menu and highlight OPTIONS.
- > Press the centre button to bring up the OPTIONS menu and highlight STANDBY SETTINGS. Press the centre button to bring up the STANDBY SETTINGS menu and use the navigation button up or down to move between AUTO STANDBY and POWER SAVING.
- > Use the navigation button left or right to select the setting you want.
- > Press the centre button to store the setting.
- > Press BACK to back up through previous menus or press and hold BACK to exit all menus.

When AUTO STANDBY is activated, a message appears on your television screen if the television has not been operated during the time set in the menu. The television then switches to standby if you do not operate it.

If you set the POWER SAVING to ON, you cannot activate the television or its sources from your link room, while the main room television is in standby. Furthermore, when POWER SAVING is set to ON you cannot activate external PLAY TIMERS.



DTV PLAY TIMER menu

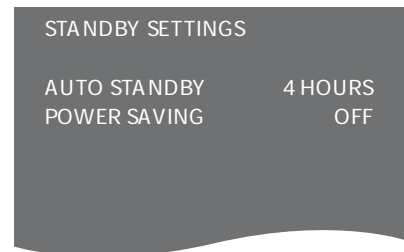

STANDBY SETTINGS menu

Set up your Beo4 remote control

You must set up your television to be operated with a Beo4 with, or without a navigation button.

Even though your remote control has a navigation button, you can choose to set your television up for operation without navigation button. This can be useful if you have a BeoLink system also comprising a television without the BEO4 SETTING menu.

If you set up your television for operation without a navigation button and your Beo4 has a navigation button, you must also change the MODE setting of your Beo4. See the Beo4 Guide for further information.

Beo4 type

In the BEO4 SETTING menu you set up whether the Beo4 remote control you are using has a navigation button or not.

To make Beo4 settings ...

- > Bring up the TV SETUP menu and highlight OPTIONS.
- > Press the centre button to bring up the OPTIONS menu, and highlight BEO4 SETTING.
- > Press the centre button to bring up the BEO4 SETTING menu.
- > Use the navigation button up or down to reveal the setting you want.
- > Press the centre button to store the setting.
- > Press BACK to back up through previous menus or press and hold BACK to exit all menus.

BEO4 SETTING

NAVIGATION BUTTON

NO NAVIGATION BUTTON

For information about menu operation with the different types of remote controls, [see page 4](#).

Feature activation

Additional features in your television can be made accessible via the FEATURE ACTIVATION menu. For information about additional features, contact your Bang & Olufsen retailer.

Feature activation key

In order for additional features to become available, a feature activation key must be entered. The feature key can be purchased from your Bang & Olufsen retailer. The key cannot be deactivated again.

To enter an activation key ...

- > Bring up the TV SETUP menu and highlight OPTIONS.
- > Press the centre button to bring up the OPTIONS menu and highlight FEATURE ACTIVATION.
- > Press the centre button to bring up the FEATURE ACTIVATION menu.
- > Select the feature, you wish to activate and press the centre button.
- > Use the number buttons to enter the 12 digit key. An incorrect number can be deleted by pressing the navigation button left, all numbers can be deleted by pressing BACK.
- > When the numbers are entered, press the centre button to accept.



HDMI MATRIX

The HDMI MATRIX feature is an additional feature which can be purchased separately. When the purchased feature activation key is entered, additional software becomes available in your television. The HDMI Matrix itself is a physical product that can be connected allowing you to connect up to 32 external sources to your television and access them via the Beo5 remote control. For information about additional features, contact your Bang & Olufsen retailer.

Important information

The HDMI MATRIX must be connected and set up by your Bang & Olufsen retailer.

- Your Beo5 remote control must be reconfigured before you can use the HDMI Matrix.
- You cannot operate the HDMI Matrix with a Beo4 remote control.
- You cannot connect more than one HDMI Matrix in a setup.
- The HDMI Matrix cannot be configured on an HDMI Expander.

HDMI MATRIX	
MATRIX	YES
INPUTS	16
IR SOCKET	PUC1
IR TYPE	PLUG
HDMI	A

Settings in the HDMI MATRIX menu ...

In the HDMI MATRIX menu, you can select settings for your HDMI Matrix.

In the CONNECTIONS menu ...

- > Open the HDMI MATRIX menu.
- > Set the field MATRIX to YES.
- > Set the field INPUTS to at least the same number of sources as you have connected.
- > Select an IR socket. You cannot select NONE.
- > Select an IR TYPE to indicate how the TV control is connected to the HDMI Matrix. If you select PLUG, you must select if MODULATION should be set to ON or OFF.
- > Select an HDMI socket. You cannot select NONE.
- > Press the **centre** button to store the HDMI MATRIX menu.
- > After you have stored your settings, select an HDMI Matrix type.
- > Press the **centre** button to store the settings.

If you at a later time disable a stored HDMI Matrix configuration by setting the HDMI Matrix field to NO, your settings for INPUTS are still saved. This means that if you set the field to YES later, the settings reappear.

Add sources to your setup ...

The sources connected to the HDMI Matrix must be registered in the television.

Configuration of inputs ...

- > Configure each input one by one.
- > Name each input by following on-screen instructions. If you do not name an input, the name from the selected PUC list is used.
- > Select a PUC source for the specific input. The sources are divided into four categories: SET-TOP BOX, DVD PLAYER/RECORDER, VIDEO RECORDER and OTHER.
- > When you store the input settings, you can configure the next input. Continue the procedure until all connected inputs are configured.
- > Press the green button to return to the CONNECTIONS menu.

HDMI MATRIX

INPUT 1	NONE
INPUT 2	NONE
INPUT 3	NONE
INPUT 4	NONE
INPUT 5	NONE
INPUT 6	NONE
INPUT 7	NONE
INPUT 8	NONE

Teletext

Daily use of teletext is described in Getting Started, however, you can also store favourite teletext pages for quick reference.

Store favourite teletext pages

Nine MEMO pages are available for each television channel's teletext service.

To create a MEMO page ...

- > Bring up a page you view often.
- > Use the navigation button left or right to move the cursor along the menu bar to SETUP and press the **centre** button. The 9 available MEMO slots are shown by number. The first is highlighted.
- > Press the **centre** button to store the current page. The cursor moves to the next available MEMO slot.
- > Use the number buttons on Beo4 to select the next teletext page you wish to store.
- > Repeat the procedure for each page you wish to store.
- > To leave the MEMO setup, move the cursor to **BACK** on the teletext menu bar and press the **centre** button.
- > Press **BACK** to leave teletext.

Day-to-day use of MEMO pages

You may wish to refer to your teletext MEMO pages quickly, for example, if you are leaving for work and wish to check traffic information on a teletext service.

To view MEMO pages ...

- > Press **TEXT** to bring up teletext.
- > Press **◀** or **▶** to move between MEMO pages.
- > Press **BACK** to leave teletext.

To delete a MEMO page ...

- > Use the navigation button left or right to move the cursor to **SETUP** and press the **centre** button
- > Move the cursor to the MEMO page you wish to delete and press the **yellow** button.
- > Press the **yellow** button again to confirm.

To view teletext subtitles for a programme ...

If you want available teletext subtitles to appear automatically for a particular programme, store the teletext subtitles page as MEMO page 9. However, subtitles are not shown when the teletext source is DVB-HD, nor when teletext is shown in dual screen.

Operate other equipment with Beo4 or Beo5

The built-in Peripheral Unit Controller acts as an interpreter between connected video equipment, such as a set-top box, video recorder or DVD player, and your Bang & Olufsen remote control.

Use the Bang & Olufsen remote control to gain access to the functions offered by your non-Bang & Olufsen equipment.

When you switch on the equipment, the functions are available via a menu-overlay on the television screen, if you use a Beo4 remote control, or via the Beo5 display.

For instruction in the various functions offered by your equipment, see the product's own guide.

Not all connected video equipment are supported by Bang & Olufsen. For further information about supported equipment, contact your Bang & Olufsen retailer.

Use the Beo4 remote control

If you have a Beo4 remote control, some functions are available directly via Beo4 when you switch on the equipment. Additional functions are available through a menu-overlay that you bring up on the screen. In this menu you can see which Beo4 buttons activate specific services or functions.

Your Bang & Olufsen retailer can provide you with a 'show mapping' survey which explains operation of the connected equipment with Beo4 in more detail.

- > Press a source button, for example VMEM, to switch on connected equipment.
- > Press MENU to bring up the menu-overlay.
- > Press the number button that activates the function you want, or press one of the coloured buttons to activate a function.

The menu-overlay for equipment connected to a main room television cannot be displayed on the television screen in the link room.

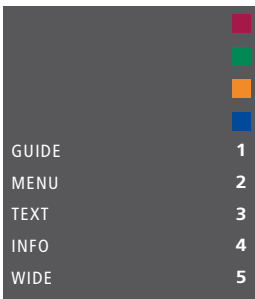

GUIDE	1
MENU	2
TEXT	3
INFO	4
WIDE	5

Example of a menu-overlay. The Beo4 buttons are shown to the right on the menu, and the functions they control are shown to the left. The menu may also list buttons on the remote control included with your connected equipment.

Direct Beo4 operation

If you know which Beo4 button activates the function you want, you can activate the function without bringing up the menu-overlay first.

While your equipment is on ...

- > Press one of the coloured buttons to activate a function.
- > Press and hold the centre button to bring up the Program Guide or the 'Now/Next' banner on the screen if you are using equipment that supports these functions.
- > Use ▲ and ▼ to step between channels*.
- > Use ◀ and ▶ to rewind and wind in, for example, recordings*.
- > Press MENU and use the number buttons to activate the function you want.

**This operation does not apply to Beo4 without navigation button.*

Use equipment menus

Once you have activated connected equipment, you can operate its own menus with your remote control.

While equipment menus are shown ...

- > Use the navigation button up, down left and right to move in menus.
- > Press the **centre** button to select and activate a function.
- > Press the number buttons to enter information in menus or services when relevant.
- > Use the coloured buttons as indicated in the menus of your connected equipment.
- > Press **BACK** to back up through previous menus or press and hold **BACK** to exit all menus.

Use the Beo5 remote control

The main functions of your equipment can be operated with the Beo5 remote control. Not all functions may be supported by Beo5. The available services and functions are shown in the Beo5 display when you activate the equipment.

- > Press a source button, for example **DTV**, to switch on connected equipment.
- > Press the button on the Beo5 display that activates the function you want.

*When you have selected connected equipment as a source, press **MENU** twice to bring up the television's main menu.*

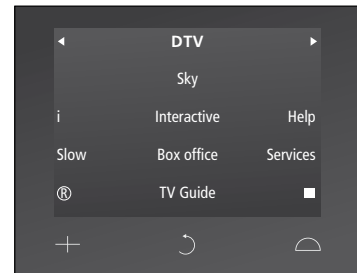

Example of a Beo5 display used to operate a set-top box.

Connect and operate an audio system

If you connect a compatible Bang & Olufsen audio system to the television using a Master Link cable, you obtain the benefits of an integrated audio/video system.

Play a CD on your audio system using speakers connected to the television, or switch on a TV programme and send the sound to your audio system speakers.

Your AV system can be placed together in one room or in two rooms with the television placed in one room and the audio system with a set of speakers placed in another.

If you want to use Master Link to integrate your audio/video system, you must set POWER SAVING to OFF, [see page 26](#).

Not all Bang & Olufsen audio systems support integration with the television.

Connect your audio system to the television

Using a BeoLink cable, connect the sockets marked MASTER LINK on the television and the audio system.

Program the AV setup with Beo4

You can set your television, placed in an AV-system, to the correct Option using Beo4. Switch the entire system to standby first.

Option setting for the television ...

- > While holding the • button (standby) on Beo4, press LIST.
- > Let go of both buttons.
- > Press LIST and use the navigation button up or down to bring up OPTION? in the Beo4 display and press the centre button.
- > Press LIST and use the navigation button to bring up V.OPT in the Beo4 display and then enter the appropriate number (1, 2 or 4).

Option setting for the audio system ...

- > While holding the • button (standby) on Beo4, press LIST.
- > Let go of both buttons.
- > Press LIST and use the navigation button up or down to bring up OPTION? in the Beo4 display and press the centre button.
- > Press LIST and use the navigation button up or down to bring up A.OPT in the Beo4 display and enter the appropriate number (0, 1, 2, 4, 5 or 6).

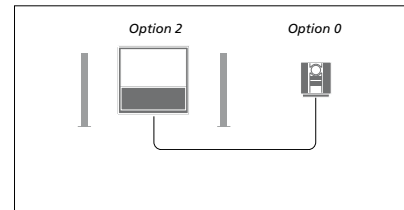

If the television and an audio system is set up in one room with all speakers connected to the television, set the television to Option 2 and the audio system to Option 0.

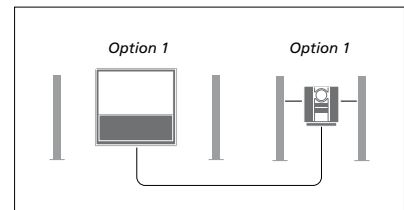

If the television (with or without additional speakers) and the audio system (with a connected set of speakers) are set up in the same room, set the television to Option 1 and the audio system to Option 1.

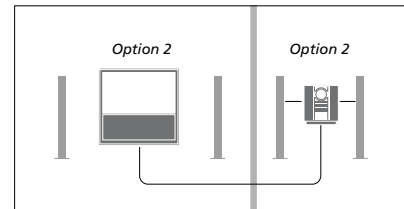

If the audio system is set up in one room, and the television (with or without additional speakers) in another, set the television to Option 2 and the audio system to Option 2.

Program the AV setup with Beo5

If your television has been set up in an AV system, you may need to set it to the correct Option with Beo5. Switch the entire system to standby first.

Option setting for the television ...

- > Place yourself in front of the television.
- > While holding the **•** button (standby), press the **centre** button to bring up the SETUP menu on Beo5.
- > Let go of both buttons.
- > Press **Option Pgm** to bring up the Option Programming display on Beo5.
- > Press the button that matches the zone in which the television is placed, for example, **Tv Area**.

Option setting for the audio system ...

- > Place yourself in front of the audio system.
- > While holding the **•** button (standby), press the **centre** button to bring up the SETUP menu on Beo5.
- > Let go of both buttons.
- > Press **Option Pgm** to bring up the Option Programming display on Beo5.
- > Press the button that matches the zone in which the audio system is placed, for example, **Audio Area**.

Use an audio/video system

If you integrate your audio system and your television, you can choose a speaker combination appropriate to the current video or audio programme, and also record video sound on the audio system.

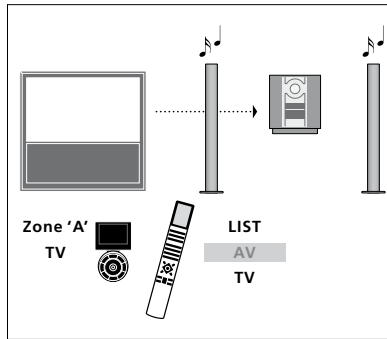

To listen to sound from a television source on your audio system speakers without switching on the screen, press **LIST** and use the navigation button up or down to bring up **AV** in the Beo4 display, then press **TV**. (Beo5: Select the zone for your audio system speakers, then press a source button, such as **TV**). Beo4 instruction is shown to the right and Beo5 instruction to the left.

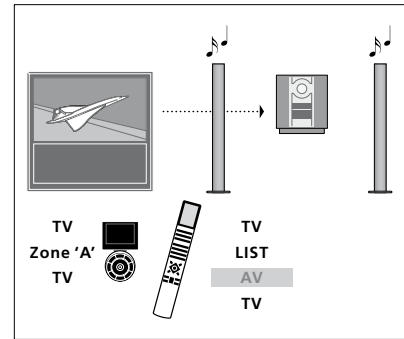

To listen to sound from a television source on your audio system speakers with the screen switched on, press **TV**, press **LIST** and use the navigation button up or down to bring up **AV** in the Beo4 display, then press **TV** again. (Beo5: Press **TV**, then select the zone for your audio system speakers and press **TV** again). Beo4 instruction is shown to the right and Beo5 instruction to the left.

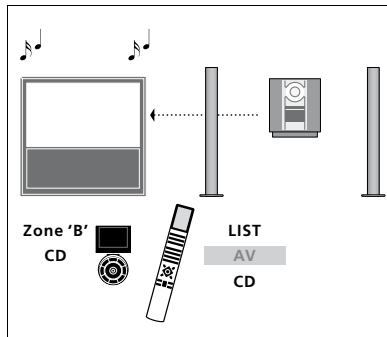

To listen to audio sound on the speakers connected to the television, press **LIST** and use the navigation button up or down to bring up **AV** in the Beo4 display, then press **CD**. (Beo5: Select the zone for speakers connected to the television, and then press an audio source button, such as **CD**). Beo4 instruction is shown to the right and Beo5 instruction to the left.

Distribute sound and picture with BeoLink

The BeoLink system makes it possible to distribute picture and/or sound to other rooms throughout the house.

For example, you can connect your television in the living room to another video system or set of speakers in another room, thereby making it possible to distribute the picture or sound to other rooms.

If you have a BeoLink distribution system installed, you can either use your television in the main room, such as a living room, or in a link room, such as a study or bedroom.

Under certain circumstances, it may be necessary to enter modulator settings.

Link connections

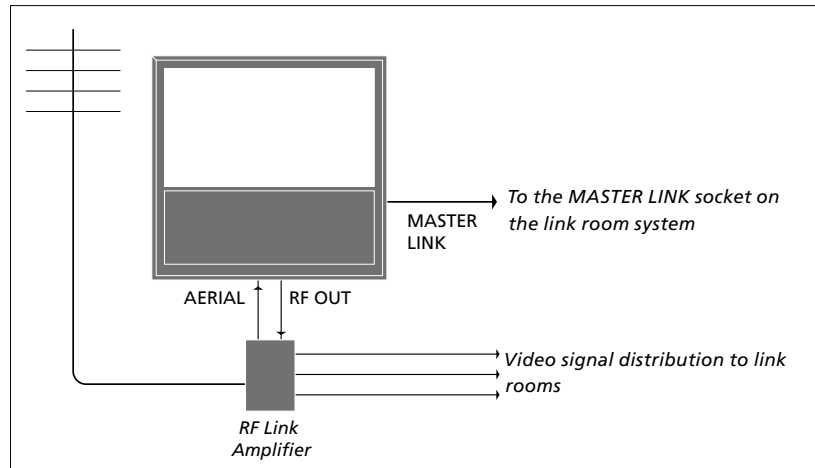

The main room television must be connected to the link room system with a Master Link cable:

- > Connect the Master Link cable to the socket marked MASTER LINK on the television.
- > If you want to distribute video signals as well, connect an ordinary aerial cable to the socket marked RF OUT on the television. Then run the aerial cable to the RF Link Amplifier and the Master Link cable to the link room. Follow the instructions enclosed with the link room equipment.

If an audio system is already connected to the Master Link socket and you wish to connect more equipment, the Master Link cable must be split in two and joined with the cable from the link room using a special junction box. Contact your Bang & Olufsen retailer for assistance.

Digital signals (HDMI) cannot be distributed from a main room television to the link room system.

System modulator

If you have an audio setup, such as a BeoLink Active/Passive, and you choose to set up a non-linkable television in the same room, you must set the system modulator to ON. The factory setting is AUTO, which must be used if you are using a linkable Bang & Olufsen television.

To switch on the system modulator ...

- > Bring up the TV SETUP menu and highlight OPTIONS.
- > Press the centre button to bring up the OPTIONS menu and highlight CONNECTIONS.
- > Press the centre button to bring up the CONNECTIONS menu, and highlight LINK TUNING.
- > Press the centre button to bring up the LINK TUNING menu and highlight MODULATOR.
- > Use the navigation button left or right to reveal ON.
- > Press the centre button to store the setting, or ...
- > ... press and hold BACK to leave all menus without storing.

Link frequency

If, for example, a TV channel in your area is broadcasted on the same frequency as the factory setting for the BeoLink system; 599 MHz, you must tune the system modulator to an unoccupied frequency. When you change the link frequency in the main room television, make sure that the link frequency in the link room television corresponds to it.

To change the link frequency ...

- > Bring up the TV SETUP menu and highlight OPTIONS.
- > Press the centre button to bring up the OPTIONS menu and highlight CONNECTIONS.
- > Press the centre button to bring up the CONNECTIONS menu, and highlight LINK TUNING.
- > Press the centre button to bring up the LINK TUNING menu and highlight FREQUENCY.
- > Use the navigation button left or right to find an unused frequency.
- > Press the centre button to store the setting, or ...
- > ... press and hold BACK to leave all menus without storing.

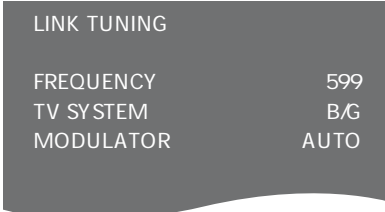

LINK TUNING	
FREQUENCY	599
TV SYSTEM	B/G
MODULATOR	AUTO

The LINK TUNING menu.

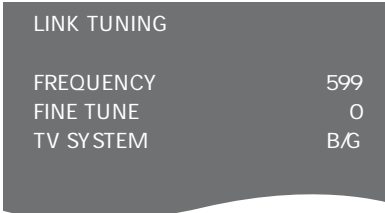

LINK TUNING	
FREQUENCY	599
FINE TUNE	0
TV SYSTEM	B/G

The LINK FREQUENCY menu.

When tuning in the link frequency in the link room, a test image is shown. FINE TUNE is only available in link room/Option 4 setups.

Your television in a link room

If you have BeoLink installed in your home and you choose to place your television in a link room, you can operate all connected systems through the television.

You must follow the procedure described below when you connect your television for use in a link room:

- 1 Connect the link room television to the mains
- 2 Using your remote control, programme the link room television to the correct Option
- 3 Disconnect the link room television from the mains
- 4 Make the necessary connections
- 5 Reconnect the link room television to the mains.

Option setting

For your entire system to function properly, it is essential that the television in the link room is set to the correct Option before you connect it to the television in the main room!

With Beo4 ...

- > While holding the **•** button (standby), press LIST on Beo4.
- > Let go of both buttons.
- > Press LIST and use the navigation button up or down to bring up **OPTION?** in the Beo4 display and press the **centre** button.
- > Press LIST and use the navigation button up or down to bring up **V.OPT** in the Beo4 display and press **6***.

With Beo5 ...

- > Place yourself in front of the link room television.
- > While holding the **•** button (standby), press the **centre** button to bring up the **SETUP** menu on Beo5.
- > Let go of both buttons.
- > Press **Option Pgm** to bring up the Option Programming display on Beo5.
- > Press the button that matches the zone in which the television is placed.

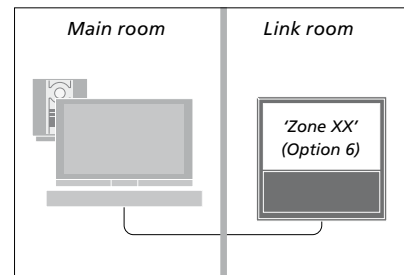

**If you connect the television for use in a link room where other link systems are already connected, such as speakers, you must set the television to Option 5 instead.*

Link room operation

When you are in the link room, you can operate all connected systems with the remote control.

Use sources present only in one of the rooms ...

- > Press the button for the source you wish to use, for example RADIO.
- > Operate the selected source as usual.

Use a main room source – source type present in both rooms ...

- > Press LIST and use the navigation button up or down to bring up LINK in the Beo4 display. (Beo5: Press Link to bring up a source display).
- > Press the button for the source you wish to use, for example TV.
- > Operate the source as usual.

Use a link room source – source type present in both rooms ...

- > Press the button for the source you wish to use, for example TV.
- > Operate the source as usual.

Listen to stereo sound in your link room ...

Usually sound distributed from a main room video source, such as a set-top box, to the link room is transmitted in mono. However, you can select stereo sound:

- > Press TV to switch on the television.
- > Press LIST and use the navigation button up or down to bring up AV in the Beo4 display. (Beo5: Press AV to bring up a source display).
- > Press, for example DTV, to activate a source connected to the main room television, such as a set-top box.

While using this function, distribution of other main room sources to other link room systems is not possible.

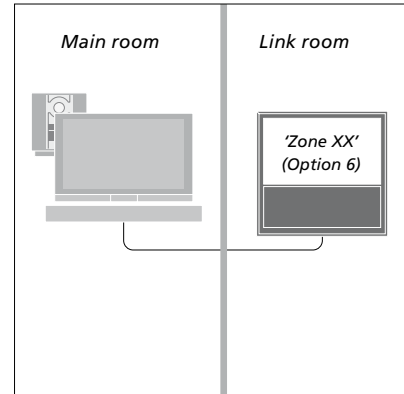

Two televisions in the same room

If you have placed your television in a room where you already have a Bang & Olufsen television, and commands from your remote control can be received by both televisions, you must change the Option setting of the television. This prevents simultaneous activation of both televisions.

When you Option program the television, disconnect the television you do not want to program from the mains. This ensures that only the television, you want to program, receives the Option programming.

One remote control for both televisions

For your television to function properly, it is essential that the television is set to the correct Option, [see page 39](#) for information on Option programming. If you have a Beo4, you must set your television to Option 4, and if you have a Beo5, you must set the television to the correct zone*.

Beo4 – Operate your television in Option 4 ...

Normally, you can activate a source, such as TV, simply by pressing the relevant source button on your remote control. However, when you set your television to Option 4, you must do the following, if you have a Beo4:

- > Press LIST* and use the navigation button up or down to bring up LINK in the Beo4 display.
- > Press a source button, such as TV.

**In order to display LINK on Beo4, you must first add it to the Beo4 list of functions. See the Guide enclosed with your Beo4.*

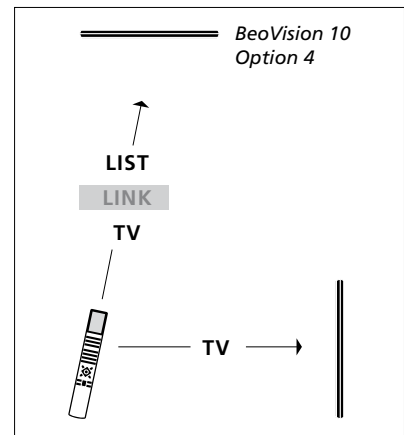

Beo4 operation.

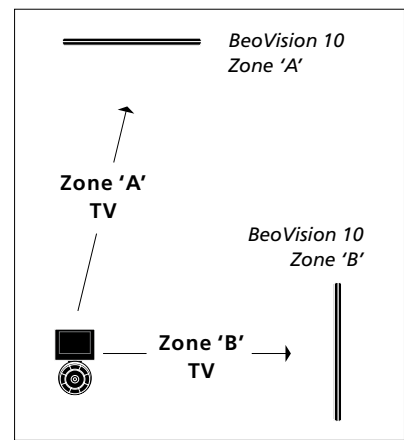

Beo5 operation.

**NOTE! For information about choice of zone, contact your Bang & Olufsen retailer.*