





## Dear Customer

This Getting Started contains information about the daily use of your Bang & Olufsen product and connected equipment. We expect your retailer to deliver, install and set up your product.

Your television offers more features and functions than described in Getting Started. Among other things; Timer functions and auto standby, editing and naming channels. These and other features are described in more detail in a Guide.

The Guides are found on [www.bang-olufsen.com/guides](http://www.bang-olufsen.com/guides)

DVB functions are described in a separate Guide. The Guides are kept up to date if new software introduces new or modified features and functions in your television.

On [www.bang-olufsen.com](http://www.bang-olufsen.com) you can also find further information and relevant FAQs about your product.

Your Bang & Olufsen retailer is your first stop for all your service queries.

*To find your nearest retailer, visit our website ...*

[www.bang-olufsen.com](http://www.bang-olufsen.com)

**WARNING:** To reduce the risk of fire or electric shock, do not expose this appliance to rain or moisture. Do not expose this equipment to dripping or splashing and ensure that no objects filled with liquids, such as vases, are placed on the equipment.

To completely disconnect this equipment from the AC Mains, disconnect the mains plug from the wall socket. The disconnect device shall remain readily operable.



The lightning flash with arrowhead symbol within an equilateral triangle, is intended to alert the user to the presence of uninsulated "dangerous voltage" within the product's enclosure that may be of sufficient magnitude to constitute a risk of electric shock to persons.



The exclamation point within an equilateral triangle is intended to alert the user to the presence of important operating and maintenance (servicing) instructions in the literature accompanying the product.

#### **Cautions**

- Ensure that the television is positioned, set up and connected in accordance with the instructions in this Getting Started.
- Place your television on a firm, stable surface. To prevent injury, use Bang & Olufsen approved stands and wall brackets only!
- Do not place any items on top of your television.
- Do not subject the television to rain, high humidity or sources of heat.
- The television is developed for indoor use in dry, domestic environments only. Use within a temperature range of 10–40°C (50–95°F), and at an altitude of no more than 1,500 m (5,000 ft).
- Do not place the television in direct sunlight, as this may reduce the sensitivity of the remote control receiver.
- Leave enough space around the television for adequate ventilation.
- Connect all cables before connecting or reconnecting any of the products in your system to the mains.
- No naked flame sources, such as lighted candles should be placed on the apparatus.
- Do not attempt to open the television. Leave such operations to qualified service personnel.
- Do not strike the glass with hard or pointed items.
- The television can only be switched off completely by disconnecting it from the wall socket.
- The supplied mains cord and plug are specially designed for the television. If you change the plug or in any way damage the mains cord, it can affect the TV performance.

# Contents

## Daily use

- 6 How to use your remote control
- 8 Introduction
- 10 Watch television
- 12 Look up teletext
- 14 Watch television via the DVB module
- 15 Change sound type and picture format

## Installation

- 20 Set up your television
- 22 Cleaning
- 23 Connection panels
- 24 First-time setup of your television

# How to use your remote control

## Beo4 operation

Your television can be operated with the Beo4 remote control.

- TV** The Beo4 display shows you the activated source or function
- TV** Switch on the TV\*<sup>1</sup>
- DTV** Switch on the DVB module and watch digital television
- TEXT** Switch on teletext
- 0 – 9** Select channels and enter information in on-screen menus
- LIST** Display extra “buttons” for functions or sources in the Beo4 display. Use  $\wedge$  or  $\vee$  to step in the list
- MENU** Bring up the main menu of the active source
- $\blacktriangle$  **Step through channels**  
Hold for continuous step
- $\blacktriangleleft$   $\blacktriangleright$  **Rewind or wind, search backwards or forwards**
- $\blacktriangleleft$   $\blacktriangleright$  **Navigation and centre button; move left, right, up and down  $\blacktriangleleft$ ,  $\blacktriangleright$ ,  $\blacktriangle$  and  $\blacktriangledown$  – move in menus by pressing the button in the direction you need**
- $\bullet$  **Centre button; press in the middle to select and accept settings**
- $\blacksquare$  **Select colour specific functions**
- $\blacktriangledown$  **Adjust volume**  
To mute, press the middle of the button
- STOP** Pause and stop playback or recording
- PLAY** Start playback of a DVD, CD or recording
- BACK** Move backwards through menus and the Beo4 list. Long press to exit menus completely
- $\bullet$  **Standby**

**Important** – for more information: [www.bang-olufsen.com](http://www.bang-olufsen.com)

**\*Beo4 buttons** Some buttons can be reconfigured during the setup process. See the Guide for further information.  
NOTE! For general information about remote control operation, see the Guide enclosed with your remote control.

## Beo5 operation



You can also operate your television with a Beo5. When Beo5 operation is different, it is described separately.

The diagram illustrates the Beo5 remote control and its interaction with a television. The television screen displays a menu titled "Living Room" with options: TV, V.MEM, RADIO, DTV, N.MUSIC, N.RADIO, PC, DVD, and CD. Below the screen is the Beo5 remote control, which features a central volume wheel, a navigation pad, and several function buttons. Lines connect these buttons to a list of their functions on the right.

- TV** (Soft button, touch screen to select\*<sup>2</sup>): Switch on a source or select a function
- Back up through Beo5 displays** (Circular arrow icon)
- Bring up Scene buttons, such as Zones or Speaker** (Dome icon): Press again to return
- Bring up digits to select channel or recording** (+ icon): Press again to return
- STOP**: Pause and stop playback or recording
- PLAY**: Start playback of a DVD, CD or recording
- BACK**: Move backwards through menus. Long press to exit menus completely
- Select colour specific functions\*<sup>3</sup>** (Coloured bar icon): Press volume wheel next to the colour
- Turn to adjust volume** (Volume wheel icon): To mute, turn quickly counter-clockwise
- Centre button is used for selecting and accepting** (Central dot icon)
- Navigation button left, right, up and down – move in menus by pressing the button in the direction you need** (Navigation pad icon)
- Rewind or wind, search backwards or forwards** (Double arrows icon)
- Step through channels or recordings** (Up/down arrow icon): Hold for continuous step
- Standby** (Red dot icon)

<sup>2</sup>**About buttons** Light grey buttons indicate that you have to press a text in the display. Dark grey buttons indicate that you have to press a hard button.

<sup>3</sup>**Coloured buttons** Press the wheel next to the colour to activate a coloured button.  
**Actual zone** Indicates the actual zone on Beo5 as it was named during the setup process.  
**Soft buttons on Beo5** Depending on the activated source, different soft buttons appear on the screen. Touch the screen to activate the function.

# Introduction

Navigate in menus and select settings using your remote control.

## Display and menus

Information about the selected source is shown at the top of the screen. On-screen menus allow you to adjust settings.

<b>TV</b>	or	<b>V MEM</b>	<b>MENU</b>
Switch on TV		Switch on connected equipment	Show menu

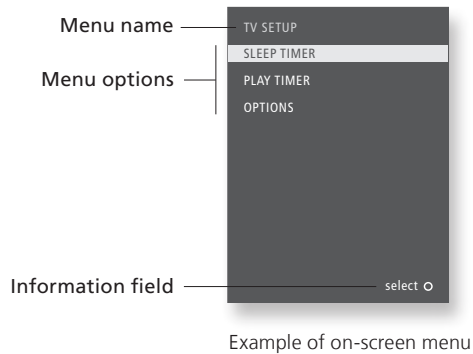

## Important

**BEO4 SETTING menu** In the 'OPTIONS' menu, you can bring up the 'BEO4 SETTING' menu. This menu is only relevant if you have a Beo4 remote control with a navigation button. Remember to set your Beo4 remote control to the correct mode. See the Beo4 Guide or contact your Bang & Olufsen retailer for further information.



## Navigate in menus

When a menu is on the screen, you can move between menu options, reveal settings or enter data.



Select option/  
setting



Enter data



Bring up sub-  
menu/store  
setting



Select option



or



Move  
backwards  
through menus

Press and hold to  
exit menus

**Remote control** On the first pages in this Getting Started, you will find an overview of the buttons on Beo4 and Beo5. For general information about remote control operation, see the Guide enclosed with your remote control.

# Watch television

Choose a TV channel by its number or switch to another channel. Adjust the sound volume and turn the TV.

## Beo4 operation



Activate the TV source to use these functions

**Switch on the TV**

Channel name

Channel number

**Select a TV channel**

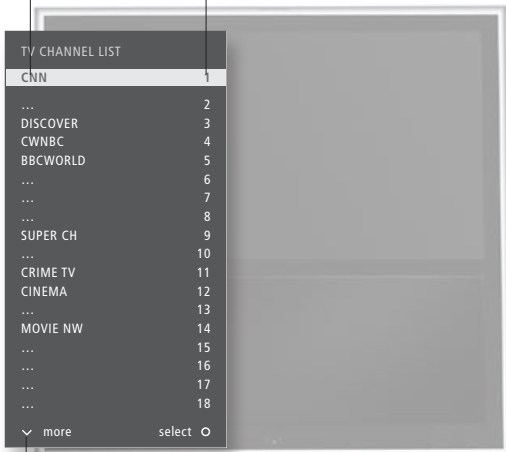

**Bring up a channel list**

**Adjust the volume**

Indicates that more channels are available















**Turn the TV**

If your television is equipped with a motorised stand, you can turn it by means of the remote control.













**Switch off the TV**

## Useful hints

**<sup>1</sup>\*TV positions** Position 1 is the far left position and Position 9 is the far right.

	Press		
	or		
Select		Select channel	Select previous channel
		or	
Hold for channel list	Select page		Accept
			
Adjust volume up or down	Press in the middle to mute sound		Press to bring sound back
			or
Press to find STAND	Bring up STAND	Turn TV	
			
			Select position* <sup>1</sup>
	Press		

## Beo5 operation

	Press		
	or		
Select		Activate numbers and select channel	Previous channel
			
Hold for channel list and select channel			Accept
			
Adjust volume. To mute, turn quickly counter-clockwise			Turn either way to bring back sound
	Stand		or
Press		Turn TV	
			
			Select position* <sup>1</sup>
	Press		

# Look up teletext

Operate teletext through the menu bar at the top of the teletext page or the arrow buttons on your remote control.

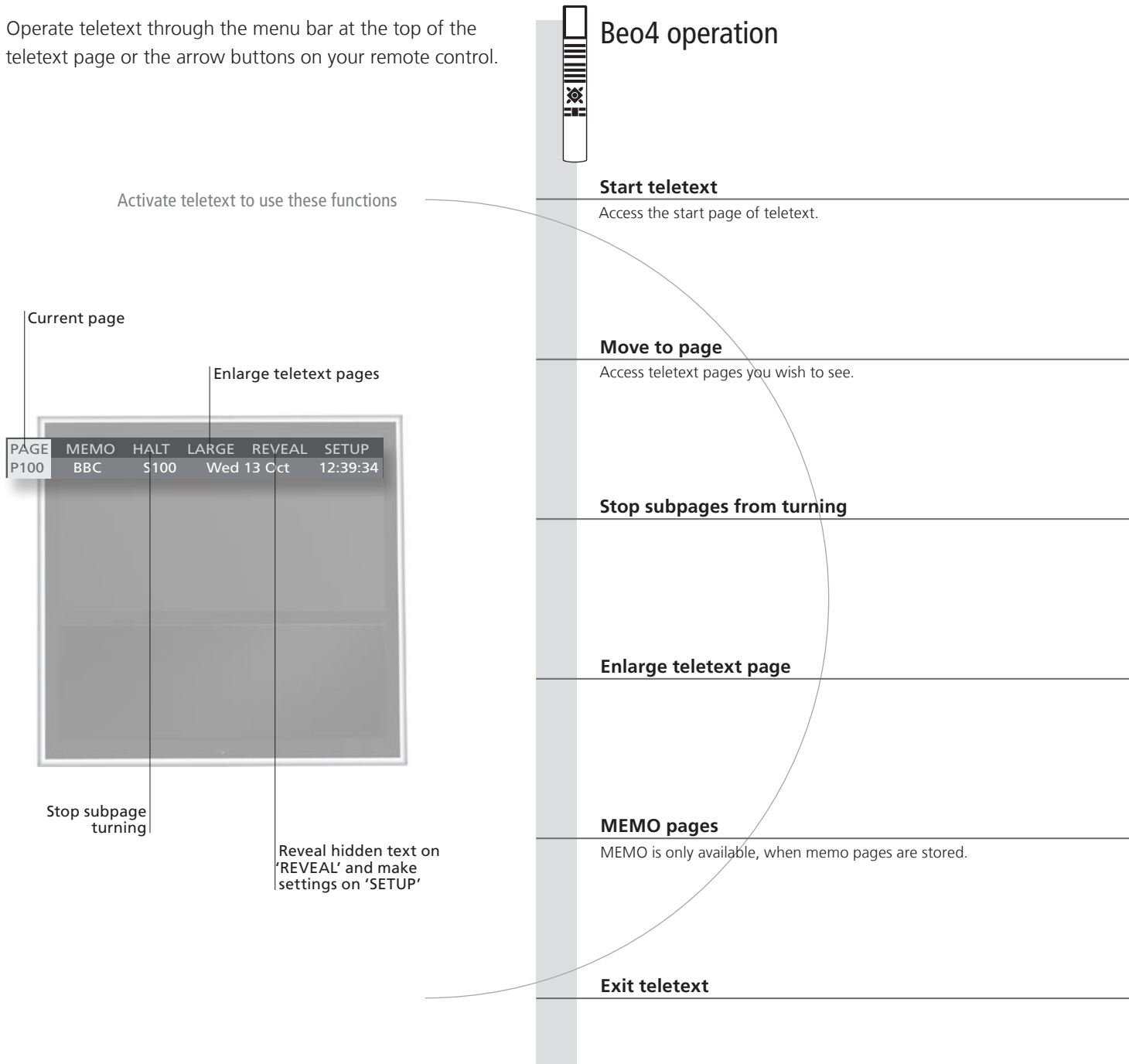

## Useful hints

- MEMO pages** For quick access, store a teletext page as a MEMO page. See the Guide for further information.
- Dual screen** When teletext is activated, pressing TEXT swaps between dual screen and full screen mode.
- REVEAL** To reveal hidden text on a teletext page, move to 'REVEAL' and press the centre button.

## Beo5 operation



## TEXT

Press repeatedly to change screen mode



Step up or down in pages    Move to 'PAGE' and select    Select page    Go to index pages (100, 200, 300 ...)



Stop turning    Move to 'HALT'    Press    Select subpage    Restart turning



Move to 'LARGE'



Press to switch between upper and lower half of page and normal viewing



Press to switch between MEMO pages    Move to 'MEMO' and switch between MEMO pages

## BACK

Press

## Text

Press repeatedly to change screen mode



Step up or down in pages    Move to 'PAGE' and select    Select page



Stop turning    Select subpage    Restart turning



Move to 'LARGE'



Switch between upper and lower half and normal viewing



Switch between MEMO pages    Move to 'MEMO' and switch between pages

## BACK

Press

**Teletext subtitles** If you would like available subtitles to appear automatically for a particular channel, store the teletext subtitles page as MEMO page 9.

## Watch television via the DVB module

When your television is equipped with the DVB module, you can receive digital terrestrial, cable and satellite programmes depending on your module options.

Activate the DTV source to use these functions

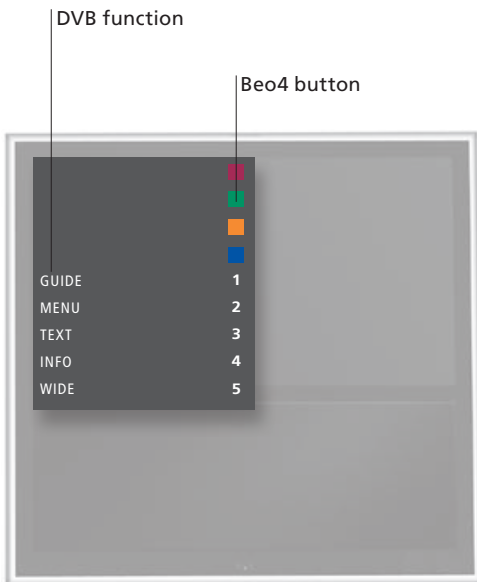

### Beo4 operation

Switch on the TV and the DVB module\*<sup>1</sup>

Select a DTV channel

Bring up and use the menu overlay













Step between groups

Bring up a channel or station list













Switch off the TV

## Useful hints

**DVB Guide** For more extensive and updated information, please look up the DVB Guide on [www.bang-olufsen.com/guides](http://www.bang-olufsen.com/guides).  
<sup>1</sup>**Activate DVB module** If the television tuner is deactivated, use the TV button to switch on the DVB module. See the Guide for further information.

	Press
 or 	Select Select channel
  or 	Press Activate the desired function
	Step between groups
  or  	Hold for channel list Select page Select channel Accept
	Press

## Beo5 operation

		Press
 or  	Select	Activate numbers and select channel
	Use the designated buttons in the display	
 	Step between groups	
  	Hold for channel list, select page or channel	Accept
	Press	

## Sound type and picture format

While you watch TV through the television tuner, you can switch between available sound types and adjust the picture format.

### Change sound type or language

Switch between available sound types and languages.

→ Bring up **SOUND** in your Beo4 display\*<sup>1</sup>



→  Press repeatedly to switch between available sound types

### Select picture format

The TV automatically adapts the picture to fill out as much of the screen as possible when you select a source, but you can select a format yourself.

→ Bring up **FORMAT** in your Beo4 display\*<sup>1</sup>

→  Select format\*<sup>2</sup>

→  or  Move picture up or down\*<sup>3</sup> or select variation\*<sup>4</sup>

#### FORMAT 1

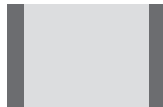

**Standard**\*<sup>4</sup>  
For panoramic view or 4:3

#### FORMAT 2



**Zoom**  
The picture is adjusted vertically

#### FORMAT 3

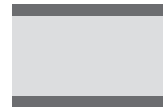

**Wide**  
For a genuine 16:9 widescreen picture

#### FORMAT 4

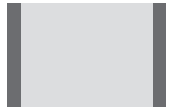

**Extended**  
The bars can be removed and the picture is shown in a 16:9 format

## Useful hints

- <sup>1</sup>\***LIST menu**
- <sup>2</sup>\***Optimise**
- <sup>3</sup>\***Move picture up or down**
- <sup>4</sup>\***Variation**

In order to display **SOUND** and **FORMAT** on Beo4, you must first add it to the Beo4 list of functions. The picture format is optimised, if you press the centre button on Beo4. On Beo5, press **Optimise**. The picture can only be moved up or down in **FORMAT 1** and **2**. In **FORMAT 1**, you can select variations of the format. On Beo5, press **Variation**.



- 20 Set up your television
- 22 Cleaning
- 23 Connection panels
- 34 First-time setup of your television

# Set up your television

Follow the guidelines for placement and connection described on this and the following pages.

## Placement options

The TV can be placed on a motorised stand or mounted on a wall bracket.

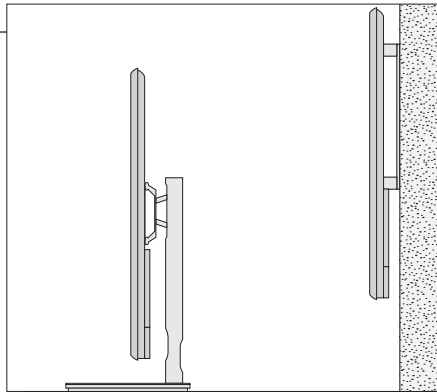

Due to the heavy weight of the TV, any moving or lifting of the TV should be performed by qualified personnel – using the proper equipment.

## Handling

We recommend that you place the TV in the packaging while you fasten the hinges for the wall bracket or the bracket for the stand.

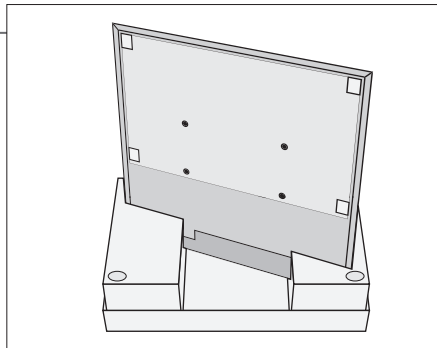

Three protection profiles have been enclosed with the TV. Use these when moving the TV to avoid scratching the frame.

## Wall bracket and stand

Set the maximum angle the TV will turn on the stand. The wall bracket can manually be turned 45° left or right depending on your setup. Remember to leave enough space around the TV to allow it to turn and tilt freely.

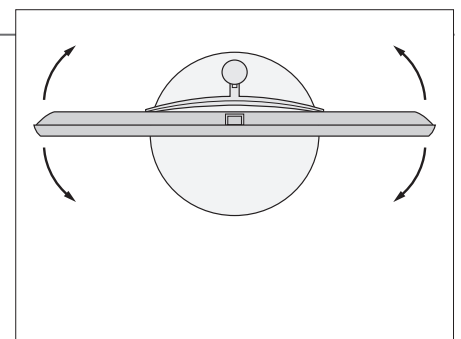
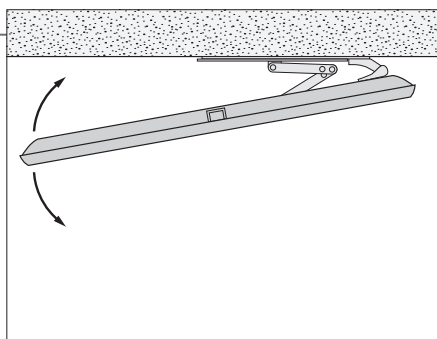

## Important

**Ventilation** To ensure proper ventilation, allow enough space around the screen. Do not cover the fans. At overheating (flashing standby indicator and an on-screen warning), switch the TV to standby, not off, in order for the TV to cool down. You cannot operate the TV during this time.

**Front glass** If the front screen glass should crack or chip, or if it should be damaged in any way, it must be replaced immediately, as it could otherwise cause injury. You can order replacement front screen glass from your Bang & Olufsen retailer.

## Overview

Locate the connection panel and other important items:

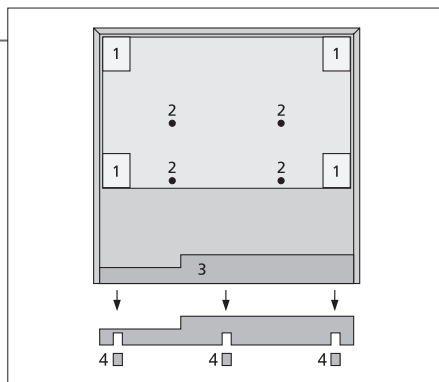

- 1 Mounting bracket for wall bracket.
- 2 Mounting bracket for stand.
- 3 Cover for the connection panel. Here you also find the mains supply connection. Pull out at the bottom to remove the cover.
- 4 Depending on your setup lead the cables through one of the three holes. Remove the part of the cover using a pair of tongs.

## Run cables

You can fasten the cables to either side or in the middle, depending on wall bracket or stand placement.

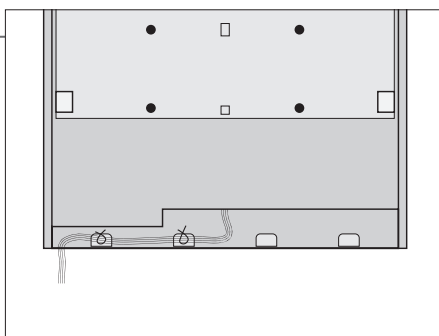

If you have a motorised stand, make sure that there is enough slack in the cables to allow the TV to turn to either side before you fasten the cables with cable strips to make a neat bundle.

## Fasten the front cloth cover

When the TV is placed on a wall bracket or stand you can attach the front cloth cover. Hold the front cover with both hands and attach it at the bottom first. Then carefully attach it to the top and adjust its position before letting go.

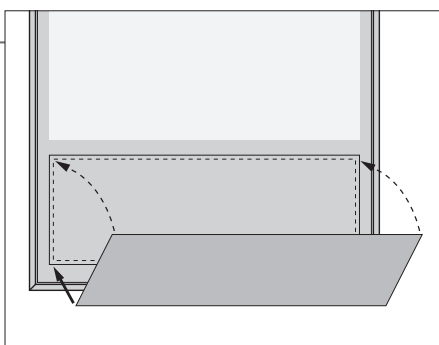

During cleaning it is recommended to remove the front cloth cover. Avoid spraying liquid directly on the screen as this may damage the speakers, use a soft cloth instead. Carefully remove the front cover by supporting it in the side and at the bottom.

## Cleaning

**Maintenance** Regular maintenance, such as cleaning, is the responsibility of the user.

**Screen** Use a mild window cleaning fluid and lightly clean the screen without leaving streaks or traces. Some micro-fibre cloths may harm the optical coating due to their strong abrasive effect.

**Cabinet and controls** Wipe dust off the surfaces using a dry, soft cloth. To remove stains or dirt, use a soft, damp cloth and a solution of water and mild detergent, such as washing-up liquid.

**Never alcohol** Never use alcohol or other solvents to clean any parts of the TV.

## Connection panels

Any equipment you connect to the main connection panel must be registered in the 'CONNECTIONS' menu.

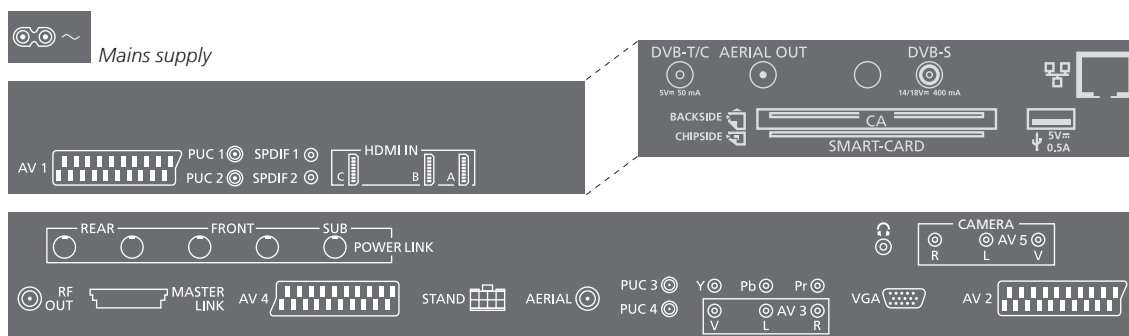

~ – **Mains supply**  
Connection to the mains supply.

 **Ethernet**  
For service use only.

 **USB**  
For service use only.

**AV (1–2 and 4)**  
21-pin sockets for connection of additional video equipment, such as a DVD player, set-top box, a decoder or video recorder.

**AV3 (video, L, R)**  
For audio connection (right and left sound channel respectively) and video signals from an external source.

## Useful hints

**Mains cord and plug** The supplied plug and mains cord are specially designed for the product. Do not change the plug and if the mains cord is damaged, you must buy a new one from your Bang & Olufsen retailer. Connect the ~ socket on the main connection panel of your TV to the wall outlet. The IR-receiver lights up in red and the TV is in standby mode and ready to be used.

**Y – Pb – Pr (AV2–4, 6)**

For video signals from an external source, e.g. HDTV source. You can use the socket in conjunction with an AV socket or a digital audio socket.

**SPDIF (1–2)**

Digital audio input socket, e.g. DVD player. You can use the socket in conjunction with an AV socket.

**PUC (1–4)**

For IR control signals to external equipment connected to an AV socket.

**HDMI IN (A–B, and C on some models)**

For High Definition Multimedia Interface video source or PC. The sources can be registered to any of the AV socket groups. To expand the number of HDMI sockets, connect an HDMI Expander to the HDMI C socket, when available, otherwise to the HDMI B socket

**VGA (AV3)**

For connection of a PC to receive analogue graphics.

**MASTER LINK**

For a compatible Bang & Olufsen audio or video system.

**RF OUT**

Aerial output socket for distribution of video signals to other rooms. Also requires an RF Link Amplifier. See the Guide for further information.

**POWER LINK (SUB)**

Use for connection of a Bang & Olufsen subwoofer.

**POWER LINK (FRONT – REAR)**

Use for connection of external loudspeakers in a surround sound setup. See the Guide for further information.

**STAND**

For connection of a motorised stand.

**AERIAL**

Aerial input socket for an analogue TV signal.

**CAMERA (R, L, video, AV5)**

For audio connection (right and left sound channel respectively) and video signals from an external source.



Connect stereo headphones.

*Note: Prolonged listening at high volume levels can cause hearing damage!*

**DVB-T/C\*<sup>1</sup>**

Aerial input socket for external aerial/cable TV network.

**AERIAL OUT**

If the signal received consists of both an analogue and a digital signal, the signal can be routed from this socket to the AERIAL socket (analogue tuner input).

**DVB-S\*<sup>1</sup>**

Aerial input socket for digital satellite signal.

**SMARTCARD**

For a card/module for access to encrypted digital channels.

<sup>1</sup>**DVB** The number and types of DVB sockets depend on which optional DVB module is installed in the television.

## First-time setup of your television

This first-time setup procedure is activated when the TV is connected to the mains and switched on for the first time. If you want to change your setup at a later date, you can access the same menus and update your settings.

### Switch on the TV

It takes the TV approx. 20 seconds to start up and become ready for use.

TV

Switch on

### Select settings

You are led through the following settings only when you switch on the TV for the first time.\*<sup>1</sup> However, the sequence of menus depend on the connections and settings you make.



or



Select setting

Accept and go to next menu item

MENU LANGUAGE	Set the on-screen menu language
STAND ADJUSTMENT	Calibrate the stand
STAND POSITIONS	Set stand positions
TUNER SETUP	Disable or enable internal TV tuner or DVB
ADJUSTMENT	Make sound adjustments
CONNECTIONS	Register connected equipment
AUTO TUNING	Tune in TV channels automatically. Available only if the TV tuner is enabled. See the Guide for further information.

This Getting Started describes operation with Beo4 in MODE1 and the BEO4 SETTING menu set to NAVIGATION BUTTON, see also page 8.

Please remember to set your Beo4 with navigation button to the MODE corresponding to the setting you make in the BEO4 SETTING menu, see the Beo4 Guide for further information.

## Information

**Connections** Select the type of equipment connected to each socket, the sockets used, the product name, and the source name.

<sup>1</sup>\*NOTE! When you have selected the preferred settings in a menu, you may have to press the green button to continue to the next menu in the first-time setup procedure. Follow the on-screen instructions.

### Calibrate the speakers

Set up the speakers to optimise sound from your listening position.

SPEAKER TYPE

First-time setup of loudspeakers applies only to speakers for TV viewing. See the Guide for further information.

SPEAKER DISTANCE

SPEAKER LEVEL

SOUND ADJUSTMENT

Adjust volume, bass, treble and loudness and preset two default speaker combinations. Select a different speaker combination at any time.

### Calibrate the stand

Set the maximum angle the TV will turn – left and right. The motorised movement of the TV will not work until the calibration process has been completed. You can only tilt the TV manually.

STAND ADJUSTMENT



At 'SET LEFTMOST POSITION' turn left to the point you wish to restrict the movement to



At 'SET RIGHTMOST POSITION' turn right to the point you wish to restrict the movement to

Accept

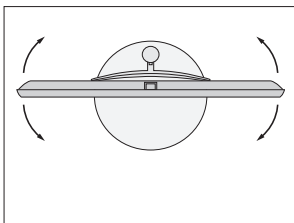

STAND POSITIONS

Set preferred preset position for the TV to turn to, when it is switched on and off.

NOTE! You need to calibrate the stand before you can use the motorised movement of the stand.

Manufactured under license from Dolby Laboratories. Dolby, Pro Logic, and the double-D symbol are registered trademarks of Dolby Laboratories.  
 Confidential unpublished works.  
 Copyright 1992–2003 Dolby Laboratories.  
 All rights reserved.

Manufactured under license under U.S. Patent #'s: 5,451,942; 5,956,674; 5,974,380; 5,978,762; 6,487,535; 7,003,467; 7,212,872 & other U.S. and worldwide patents issued & pending.  
 DTS, DTS Digital Surround, ES, and Neo:6 are registered trademarks and the DTS logos, and Symbol are trademarks of DTS, Inc.  
 © 1996-2008 DTS, Inc.  
 All Rights Reserved.

 This product is in conformity with the provisions of the Directives 2004/108/EC and 2006/95/EC.

This product incorporates copyright protection technology that is protected by U.S. patents and other intellectual property rights. Use of this copyright protection technology must be authorized by Rovi, and is intended for home and other limited viewing uses only unless otherwise authorized by Rovi. Reverse engineering or disassembly is prohibited.

HDMI, the HDMI logo and High-Definition Multimedia Interface are trademarks or registered trademarks of HDMI Licensing LLC.



**Waste Electrical and Electronic Equipment (WEEE) – Environmental protection**

Electrical and electronic equipment, parts and batteries marked with this symbol must not be disposed of with normal household waste; all electrical and electronic equipment, parts and batteries must be collected and disposed of separately.

When disposing of electrical and electronic equipment and batteries by use of the collection systems available in your country, you protect the environment, human health and contribute to the prudent and rational use of natural resources. Collecting electrical and electronic equipment, batteries and waste prevents the potential

contamination of nature with the hazardous substances which may be present in electrical and electronic products and equipment. Your Bang & Olufsen retailer will advise you of the correct way of disposal in your country.

*If a product is too small to be marked with the symbol, it will appear in the User guide, on the Guarantee certificate, or on the packaging.*

---

*All Bang & Olufsen products comply with applicable environmental legislation throughout the world.*





