

BeoVision 7

Guide

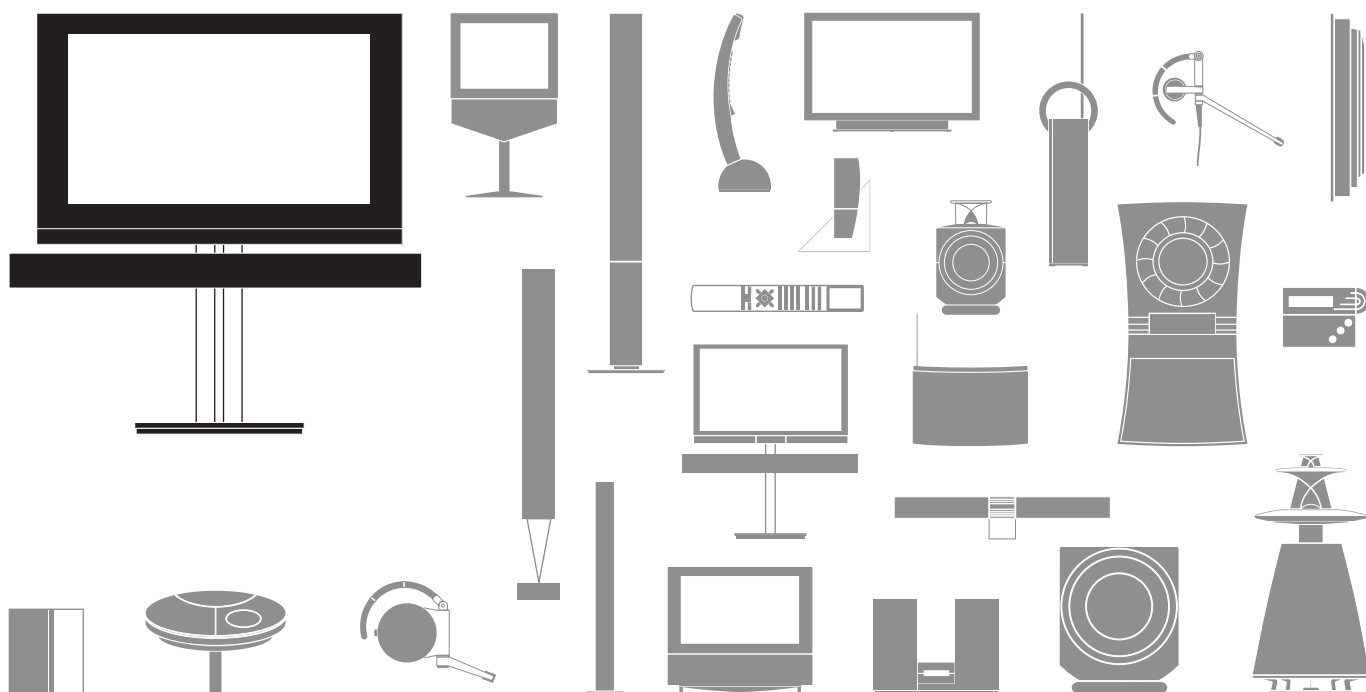

Cautions

- Avoid placing your television in direct sunlight or direct artificial light, such as a spotlight, as this may reduce the sensitivity of the remote control receiver. Also if the screen is overheated, black spots may appear in the picture. These spots disappear again, once the television cools down to normal temperature.
- Make sure that the television is set up, placed and connected in accordance with this Guide. To prevent injury, use Bang & Olufsen stands or wall brackets only.
- The television is developed for indoor use in dry, domestic environments only. Use within a temperature range of 10–40°C (50–105°F).
- Do not place any items on top of the television.
- Always place your television on a firm and stable surface.
- Do not attempt to open the television. Leave such operations to qualified service personnel.
- The disconnect device shall remain readily operable.



Dear Customer

This Guide contains information about the daily use of your Bang & Olufsen product and about connecting and operating external equipment. We expect your retailer to deliver, install and set up your product.

On the Bang & Olufsen website, www.bang-olufsen.com, you can find further information and relevant FAQs about your product.

The needs of the user are considered carefully when designing and developing Bang & Olufsen products. Therefore, please take the time to tell us about your experience with your product.

To contact us, visit our website on ...
www.bang-olufsen.com

or write to: Bang & Olufsen a/s
BeoCare
Peter Bangs Vej 15
DK-7600 Struer

or fax: Bang & Olufsen
BeoCare
+45 9785 3911 (fax)

Contents

4	Watch television
6	Teletext
8	Use the Blu-ray player
11	BeoLink
21	Advanced use
33	Installation - setup

Technical specifications, features and the use thereof are subject to change without notice.

How to use your remote control

You can operate your television with Beo5 or Beo4. The instructions in this Guide are mainly based on Beo5.

Beo5 operation



The Beo5 remote control features a touch screen at the top and a circular volume wheel below. The TV screen shows a menu for the 'Living Room' zone with options like TV, V.MEM, RADIO, DTV, N.MUSIC, N.RADIO, PC, DVD, and CD.

- TV** Soft button, touch screen to select*¹
Switch on a source or select a function
- Back** Back up through Beo5 displays
- Scene** Bring up SCENE buttons such as Zones or Speaker
Press again to return
- +** Bring up digits to select channel
Press again to return
- STOP** Back up through menus or press once to pause playback and twice to stop
- PLAY** Start playback
- BACK** Exit menus completely
- Coloured buttons** Select colour specific functions*²
Press volume wheel next to the colour
- Volume wheel** Turn to adjust volume
To mute, turn quickly counter-clockwise
- GO** Press centre button to accept and store settings
- Left/Right arrows** Step through screen menus
- Left/Right double arrows** Search backwards or forwards
- Up/Down arrows** Step through channels
Hold for continuous step
- Red dot** Standby

Beo4 operation



The Beo4 remote control features a large touch screen at the top and a series of physical buttons below. The screen shows 'TV' as the activated source.

- TV** The Beo4 display shows you the activated source or function
- TV** Switch on the TV*³
- DVD** Switch on the optional Blu-ray player
- 0-9** Select channels and enter information in on-screen menus
- MENU** Bring up the main menu of the active source
- TEXT** Switch on teletext
- Left/Right double arrows** Search backwards or forwards or move in menus
- GO** Accept and store settings and start playback
- Up/Down arrows** Step through channels or move in menus
Hold for continuous step
- Coloured buttons** Select colour specific functions
- Volume wheel** Adjust volume
To mute, press the middle of the button
- LIST** Display extra 'buttons' on the Beo4
Press repeatedly to change 'buttons'
- STOP** Back up through menus or press once to pause playback and twice to stop
- EXIT** Exit menus
- Red dot** Standby

Useful hints

- ¹***About buttons** Light grey buttons indicate that you have to press a text in the display. Dark grey buttons indicate that you have to press a hard button.
- ²***Coloured buttons** Press the wheel next to the colour to activate a coloured button.
- Actual zone** Indicates the actual zone as it was named during the setup process.
- Soft buttons** Depending on the activated source, different soft buttons appear on the screen. Touch the screen to activate the function.

³***Marked buttons** can be reconfigured during the setup process. See p. 44.

My reconfiguration:

TV _____

DTV _____

NOTE! For general information about remote control operation, see the Guide enclosed with your remote control.

Watch and store movies and listen to different sources, such as a connected set-top box or a music centre.

Easy use

Display and menus

Information about the selected source is shown at the top of the screen. On-screen menus allow you to adjust settings.

...	TV	or	DVD	Menu
Select TV's zone	Switch on TV		Switch on optional Blu-ray player	Show menu

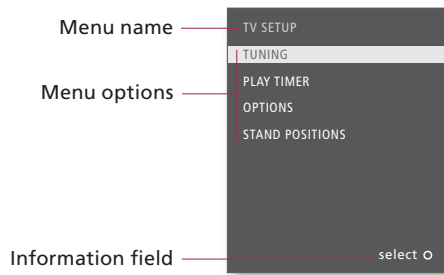

Navigate in menus

When a menu is on the screen, you can move between menu options, reveal settings or enter data.

< ◁ ▷ >	+	0-9	GO	[Colorful arrows]	BACK
Select option/setting	Enter data		Bring up sub-menu/store setting	Select option	Exit menus ⁴

Watch television • Teletext • Use the Blu-ray player

Important – for more information: www.bang-olufsen.com

Remote control The instructions in this Guide are mainly based on the Beo5 remote control, but you can also operate the TV with Beo4. On the fold-out page in this Guide, you will find an overview of the buttons on Beo5 and Beo4. For general information about remote control operation, see the Guide enclosed with your remote control.

⁴*NOTE! Hold STOP to leave the menu.

Watch television

Choose a TV channel by its number or switch to another channel or source. Adjust the sound volume, change the sound type or language and turn the TV.

Activate the TV source to use these functions

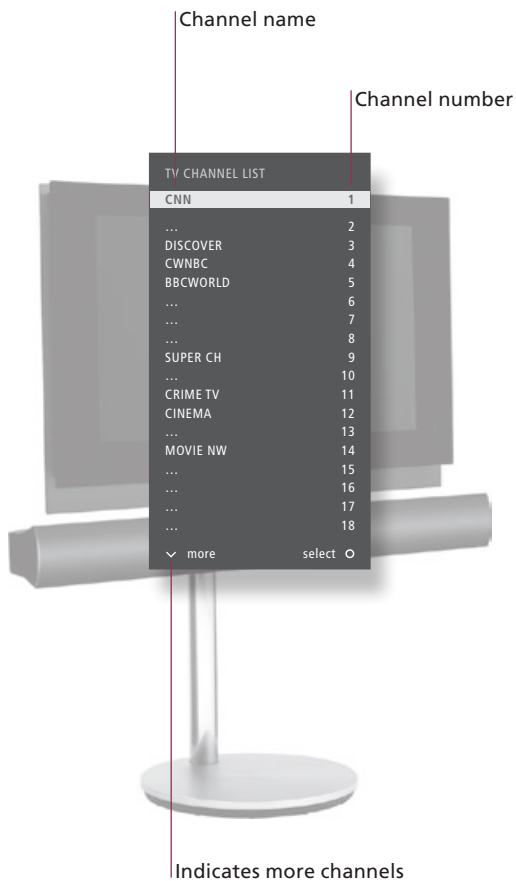

Beo5 operation

Switch on the TV

Select a TV channel

Bring up a channel list

Adjust the volume

Turn the TV











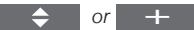





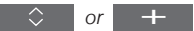





See second source

Divide the screen to watch two sources at the same time.*¹

Switch off the TV



















Useful hints

- ¹ * **Second source** You can bring up two video sources. With **Swap** you can make the left and right pictures switch places. With **BACK** you leave the function and go to the source on the left. You can also just select the source you wish to go to. See also p. 40 for information about HDMI sources.

	TV
Press	
 or 	Select
	Activate numbers
	Select channel
	Hold for channel list
	Select page
 or 	Select channel
	Accept
	
	Adjust volume. To mute, turn quickly counter-clockwise
	Bring back the sound by turning the wheel either way.
	Press
	Press
 or  or 	Turn TV
	Select position* ²
	Press
	Select source
	Swap pictures
	Press



Beo4 operation

	TV
Press	
 or 	Select
	Select channel
	Previous channel
	Hold to activate
 or 	Select page or channel and accept
	
	Adjust volume
	To mute, press in the middle of the button
	Select 'STAND'
 or 	Turn TV
	Select position* ²
	Select 'P-AND-P'
	Select source
	Swap pictures
	Press

²*TV positions Position 1 is the far left position and Position 9 is the far right.

NOTE! To use the stand function, you have to calibrate the stand first, see p. 45. To preset positions for the TV to turn to, see p. 48.

Teletext

Operate teletext through the menu bar at the top of the teletext page or the arrow buttons on your Beo5.

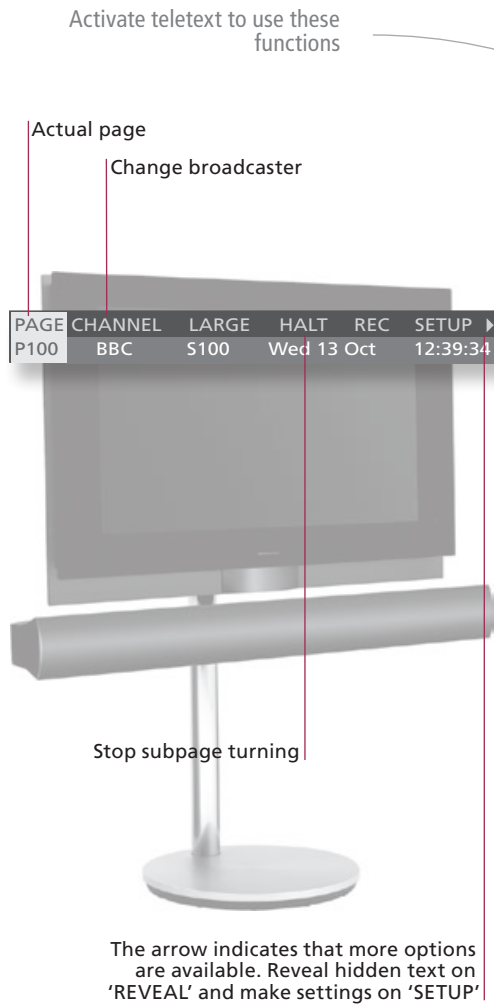

Beo5 operation



Start teletext

Access the start page of teletext.

Move to pages

Access teletext pages you wish to see.

Change teletext service*¹

Access teletext pages of other broadcasters.

Stop subpages from turning

Reveal hidden messages

... and the like.

Create MEMO pages

Nine MEMO pages are available for each channel's teletext service.*²

View a MEMO page

'MEMO' is only available if you have stored MEMO pages.

Delete a MEMO page

Exit teletext

Leave the teletext function.

Glossary

- Beo5 teletext point** With the inner arrow buttons on Beo5 you can navigate in page references in a teletext page. Go to a page referred to by pressing the **centre** button and back again by pressing **BACK**.
- ¹*Teletext service MEMO pages** Each channel provides its own teletext service. Change easily between teletext pages of different channels. Store a teletext page as a MEMO page to be able to access it quickly.
- Large teletext** To enlarge the size of the teletext page, bring up teletext, move to 'LARGE' in the menu bar and press the **centre** button repeatedly to switch between the upper and lower half of the page and normal page size.

Text				
Press repeatedly to change screen mode				
0-9	or	<	◄	GO
Select page	Move to 'PAGE'	Select page	Go to index pages (100, 200, 300 ...)	
>	◇	GO	◇	GO
Move to 'CHANNEL' or 'MEMO' then 'CHANNEL'	Bring up channel list	Select channel	Accept	
STOP	or	<>	GO	◇
Stop turning	Move to 'HALT'	Press	Select subpage	Restart turning
<>	GO			
Move to 'REVEAL'	Accept			
0-9	<>	GO	GO	<>
Select page	Move to 'SETUP'	Accept	Store current page	Move to 'BACK'
<>	◇			
Move to 'CHANNEL' or 'MEMO'	Select MEMO page			
<>	GO	<>	Press	Delete
Move to 'SETUP'	Accept	Select MEMO page		
BACK				
Press				

TEXT				
Press				
0-9	or	◄	◇	GO
Select page	Move to 'PAGE' and select	Index pages		
▶▶	◇	GO	◇	GO
Move to 'CHANNEL' or 'MEMO' then 'CHANNEL'	Press, select channel and accept			
STOP	◇	or	0-9	GO
Stop turning	Select subpage and restart turning			
◄▶	GO			
Move to 'REVEAL'	Accept			
0-9	◄▶	GO	GO	
Select page	Move to 'SETUP'	Accept then store		
◄▶	◇			
Move to 'CHANNEL' or 'MEMO'	Select MEMO page			
◄▶	GO	◄▶	Press	Press twice
Move to 'SETUP'	Press	Select page		
EXIT				
Press				

²*Teletext subtitles If you would like available teletext subtitles to appear automatically for a particular channel, store the teletext subtitles page as MEMO page 9.

Dual screen When teletext is activated, pressing 'Text' swaps between dual screen and full screen mode.

NOTE! If your TV is linked via a Master Link cable to another TV, stored MEMO pages are not shared among these TVs. MEMO pages must be stored manually on each linked TV.

Use the Blu-ray player

If your TV is equipped with the optional Blu-ray player, you can watch both Blu-ray discs and DVDs. With Blu-ray discs the menu uses blue colours and with DVDs the menu uses red colours.

Activate the source of the Blu-ray player to use these functions

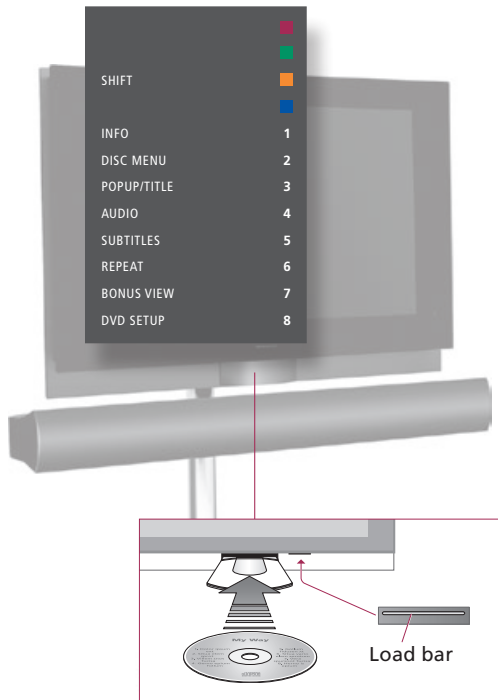

Press the load bar below the screen and place the disc in the loader with the label facing upwards. Hold the load bar to begin playback automatically.
Important! Do not use disc adaptors.

Beo5 operation



Switch on the Blu-ray player

Select a function

Bring up different menus, e.g. **INFO** menu to move to specific title/chapter or point in time. Change audio/subtitle language or angle.

Play a disc

Pause or stop playback

Pause or stop playback of a disc.
Not all Blu-ray discs support the resume function.

Slow playback

Playback in slowmotion.*¹

Change chapters or tracks

Step in chapters/tracks on a disc.

Switch off the Blu-ray player

Useful hints

'ANGLE' and 'BONUS VIEW' menus 'ANGLE' and 'BONUS VIEW' menus are displayed if 'PLAYBACK STATUS' is set to 'EXTENDED' in the 'SETUP' menu and the information is available.

'DVD SETUP' menu Use the main menu to make your own settings for playback.

***Slow playback** Slow playback backwards is not possible.

NOTE! On Beo4 you must press the yellow button first to activate the player's functions, e.g. resume playback.



Beo4 operation

DVD	Press
...	Select function
PLAY	Start playback
STOP	Once to pause, press again to stop. Third to return to beginning of disc
PLAY	Resume playback
STOP ▶▶ ▲	Pause playback Slow playback Step in frames
PLAY	Resume playback
◀▶ <i>or</i> ◀▶▶	Step in chapters/tracks. Cue during playback
PLAY	Resume playback
TV <i>or</i> ●	Press

DVD	Press
MENU <i>or</i> ■ 1-8	Bring up menu overlay Select function
■ GO	Start playback
STOP ■ GO	Once to pause, press again to stop. Third to return to beginning of disc Resume playback
STOP ■ ▶▶ ■ ▲ ■ GO	Pause playback Slow playback or step in frames Resume playback
■ ◀▶ <i>or</i> ■ ◀▶▶ ■ GO	Step or cue Resume playback
TV <i>or</i> ●	Press

TV menu On Beo4 press **MENU** twice to bring up the TV's main menu, when DVD is selected as source.

Handling discs If a loaded disc is not recognised, it is ejected and 'LOAD' is shown in the display window. Check for disc faults such as fingerprints or scratches. The disc may also have an incompatible format.

NOTE! If you are asked to press a coloured button, press the specific button twice, if you have a Beo4.



- 12 BeoLink system
- 14 Connect and set up an audio system
- 16 Connect and set up a BeoLink system
- 17 Your television in a link room
- 18 Two televisions in the same room



BeoLink system

If you have a BeoLink system, you can operate all connected sources from both the main room and link rooms.

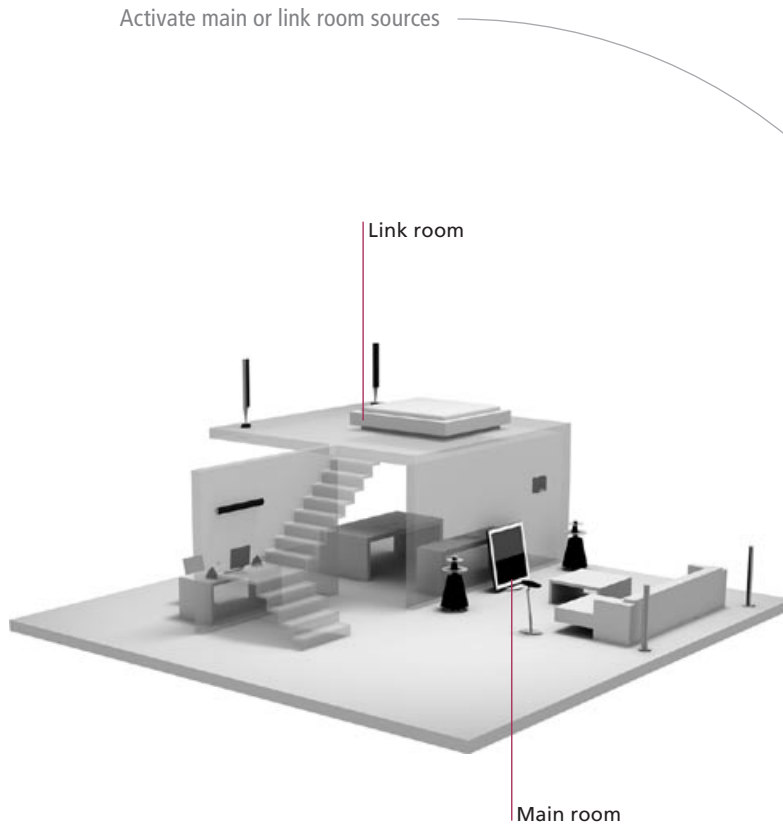

Beo5 operation



TV sound on the audio speakers

Listen to sound from a TV source on your audio system speakers.

Audio sound on the TV speakers

Listen to audio sound on the speakers connected to the TV.

Use a source present in one room

Activate a main or link room source from a link room. The source type is only present in one room.

Use a link room source

Activate a link room source in a link room. The source type is present in both rooms.

Use a main room source

Activate a main room source from a link room. The source type is present in both rooms.

Stereo sound in a link room

If stereo sound is selected in the link room, you cannot distribute other main room sources to the link room system.*¹

Useful hints

- Options** To use all functions properly, the products must be set to the correct options. See p. 14.
- Main room source** This is the central source from which you can distribute sound and pictures to link room sources.
- Link room source** This source is placed in the link room and through the source you can receive sound and pictures from connected main room sources.
- Audio system** Only Bang & Olufsen audio systems with Master Link support integration with the TV.



Beo4 operation

...	TV	
Select audio speaker zone	Select video source	
...	CD	
Select TV speaker zone	Select audio source	
RADIO		
Select source	Operate source as usual	
TV		
Select source	Operate source as usual	
Link	TV	
Press	Select source	Operate source as usual
TV	AV	DTV
Switch on TV	Press	Select main room source

LIST	TV	
Select AV* ²	Select video source	
LIST	CD	
Select AV* ²	Select audio source	
RADIO		
Select source	Operate source as usual	
TV		
Select source	Operate source as usual	
LIST	TV	
Select LINK* ²	Select source	Operate source as usual
TV	LIST	DTV
Switch on TV	Select AV* ²	Select main room source

¹*Sound Usually sound distributed from a main room video source, such as a set-top box, to the link room is transmitted in mono. However, you can select stereo sound.

Changes in link room setup If you move your link room products to other rooms, remember to get your Beo5 remote control reconfigured by your Bang & Olufsen retailer.

²*NOTE! In order to display AV and LINK on Beo4, you must first add it to the Beo4 list of functions. See the Guide enclosed with your Beo4.

Connect and set up an audio system

To obtain the benefits of an integrated audio/video system, connect a compatible Bang & Olufsen audio system to the TV using a Master Link cable.

1. Connect the audio system

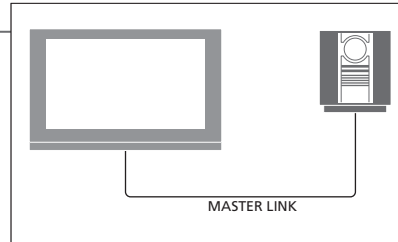

Connect the available sockets marked MASTER LINK on the TV and the audio system using a Master Link cable.

2. Set option for TV

If your TV has been set up in an audio/video system, set it to the correct option. Switch the entire system to standby first and place yourself in front of the TV.

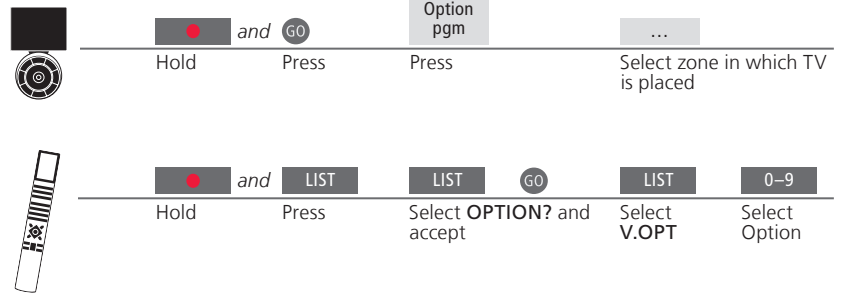

3. Set option for audio system

Set the audio system to the correct option. Switch the entire system to standby first and place yourself in front of the audio system.

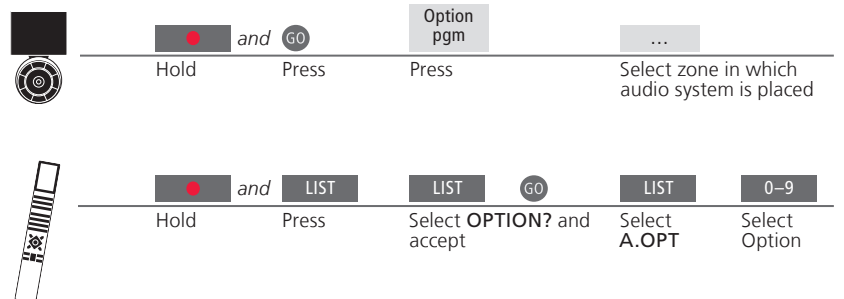

Useful hints

TV and audio speakers

Play a CD on your audio system using speakers connected to the TV, or switch on a TV programme and send the sound to your audio system speakers.

Choice of options

If you have a Beo4 remote control, options for the TV can be 1, 2, or 4 in a main room and 5 or 6 in a link room. Options for the audio system can be 0, 1, 2, 5, 6. See also p. 17.

Your audio/video system can be placed together in one room, or in two rooms with the TV in one and the audio system with a set of speakers in another.

Select options

To set the correct options with the Beo5 remote control, you must select the zone in which your product is placed, see p. 14. To set the correct options with the Beo4 remote control, you can get an overview of options on this page.

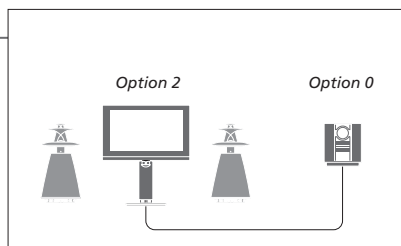

The TV and audio system are set up in one room with all speakers connected to the TV. Set the TV to Option 2 and the audio system to Option 0.

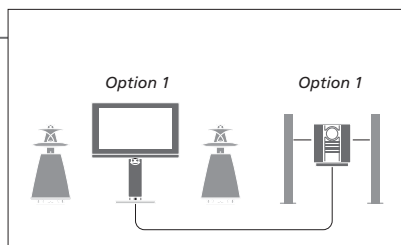

The TV with or without additional speakers and an audio system with a connected set of speakers are set up in one room. Set the TV to Option 1 and the audio system to Option 1.

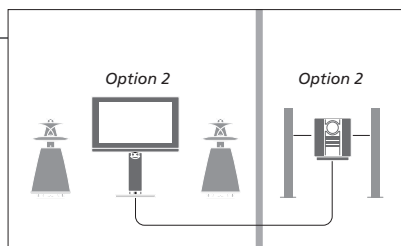

The audio system is set up in one room and the TV with or without additional speakers in another. Set the TV to Option 2 and the audio system to Option 2.

Options For information about Option 4, 5 and 6, see pp. 17–18.

NOTE! Not all Bang & Olufsen audio systems support integration with the TV.

Connect and set up a BeoLink system

Connect and set up a BeoLink system to see pictures and hear sound in link rooms. You can, for example, connect the living room TV to another video system or to a set of speakers in another room.

Make link connections

To distribute video signals to link rooms, it is necessary to connect an RF Link Amplifier to the main room TV and a link room TV.*¹

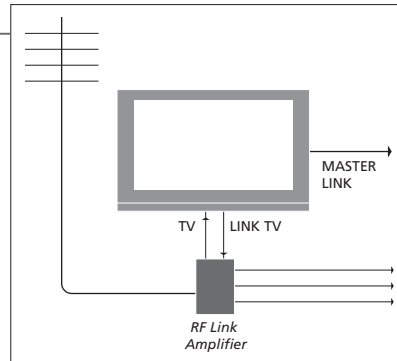

Connect the Master Link cable to the available socket marked MASTER LINK on the TV.

To distribute video signals to link rooms, connect an ordinary aerial cable to the socket marked LINK TV on the main connection panel. Then run the aerial cable to the RF Link Amplifier and the Master Link cable to the link room. Follow the instructions enclosed with the link room equipment.

Switch on the system modulator

If you have an audio setup, such as a BeoLink Active/Passive, and you set up a non-linkable TV in the same room, you must set the system modulator to 'ON'. The factory setting is 'AUTO', which must be used if you are using a linkable Bang & Olufsen TV.



Change the link frequency

If, e.g., a TV channel in your area is broadcasted on the same frequency as the factory setting for the BeoLink system; 599 MHz, you must tune the system modulator to an unoccupied frequency.*²



Useful hints

¹*Connected equipment

If an audio system is already connected to the MASTER LINK socket and you wish to connect more equipment, the Master Link cable must be split in two and joined with the cable from the link room using a special junction box. Contact your Bang & Olufsen retailer for assistance.

²*Link frequency

When you change the link frequency in the main room TV, make sure that the link frequency in the link room corresponds to it.

NOTE! Only sources with an analogue signal can be distributed from a main room TV to the link room system.

If you have a BeoLink system, operate all connected systems through the TV in a link room.

Connect link room TV

Follow the procedure described here when you connect your TV for use in a link room.

- 1 Connect the link room TV to the mains supply.
- 2 Using your remote control, programme the link room TV to the correct option.
- 3 Disconnect the link room TV from the mains.
- 4 Make the necessary connections.
- 5 Reconnect the link room TV to the mains supply.

Set option for a link room TV

For your entire system to function properly, it is essential that the TV in the link room is set to the correct option before you connect it to the system in the main room. Place yourself in front of the link room TV.

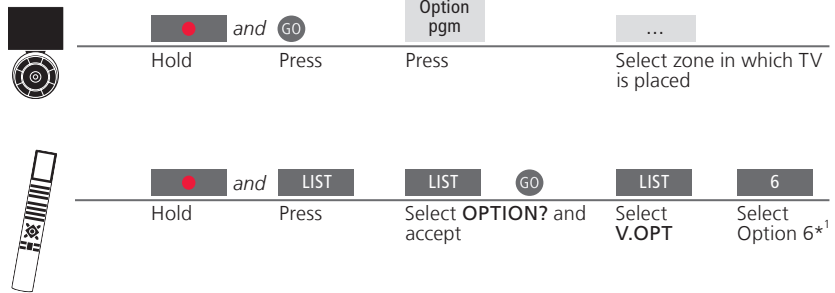

Timer programming Programme a Play Timer on the TV in the main room.

¹*NOTE! If you have a Beo4 and you connect the TV for use in a link room where other link systems are already connected, such as speakers, you must set the TV to Option 5 instead.

Two televisions in the same room

If you have two TVs in the same room and one remote control for both TVs, it is essential that the TVs are set to the correct options, for them to function properly.

Set the correct option

If you place your TV in a room where you already have a Bang & Olufsen TV and commands from your remote control can be received by both TVs, you must change the option of the secondary TV to prevent simultaneous activation of both TVs. Place yourself in front of the secondary TV.

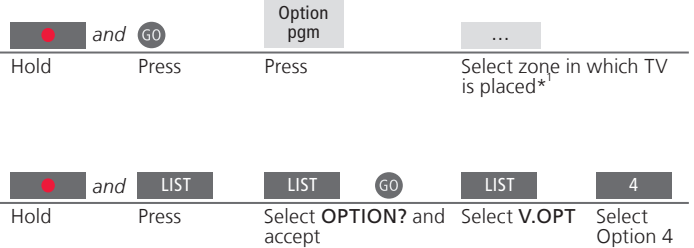

Beo5 – operate the TVs

Normally you can activate a source simply by pressing the relevant source button, but if you have two TVs in the same room, you must remember first to select the zone of the TV you wish to use, if you have a Beo5.

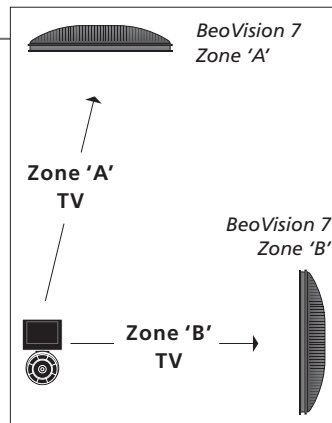

Useful hints

Teletext with Option 4 In order to use teletext on a TV set to Option 4, you must set up Beo4 to VIDEO 3. This limits the Beo4 functions that can be used with TVs set to other options. For more information, see the Guide enclosed with your Beo4.

¹*NOTE! For information about choice of zone, contact your Bang & Olufsen retailer.

Beo4 – operate TV in option 4

Normally you can activate a source simply by pressing the relevant source button, but if your TV is set to Option 4, you must do the following to activate a source, if you have a Beo4.

However, if you wish to dedicate a remote control to your secondary TV, contact your Bang & Olufsen retailer.

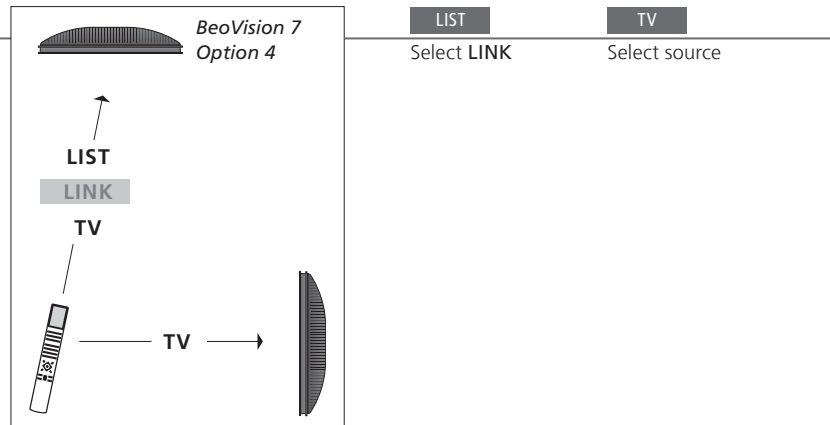

LINK on Beo4 In order to display LINK on Beo4, you must first add it to the Beo4 list of functions. See the Guide enclosed with your Beo4 for more information.



- 22 Surround sound and Home cinema
- 23 Sound type
- 24 Wake-up Timer
- 25 Play Timer
- 26 Edit and add TV channels
- 27 Adjust picture and sound settings
- 28 The pincode system
- 29 Tuner setup
- 30 Operate other equipment with Beo5 or Beo4

Surround sound and Home cinema

When you add Bang & Olufsen loudspeakers and a projector, you can turn your TV into a Home cinema system with surround sound. You can also select a picture format to customise the viewing experience.

Select speakers for movie sound

The TV automatically selects the optimal sound, when you select a source, but you can select an available speaker combination that suits the source you are using yourself.

Bring up **Scene** display on Beo5*¹ → Select **Speaker** display → Select speaker combination*²

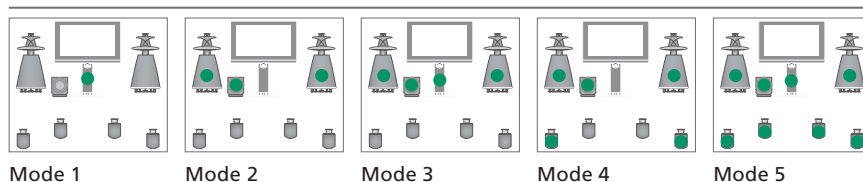

Select picture format

The TV automatically adapts the picture to fill out as much of the screen as possible, when you select a source, but you can select a format yourself.

Bring up **Scene** display on Beo5*¹ → Select **Picture** display → Select format*² → Adjust picture up or down

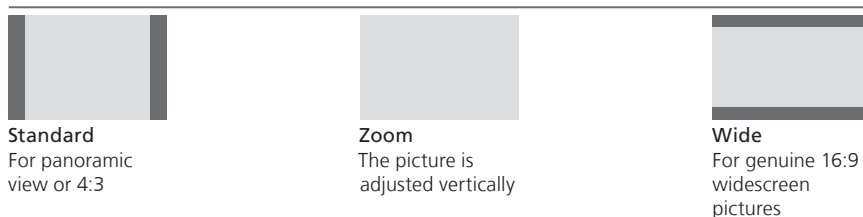

Switch to Home cinema

Move the picture from the TV screen onto a connected projector screen.

Bring up **Scene** display on Beo5*¹ → Select **Cinema** display → Select **Cinema** to switch between Home cinema and TV mode

Useful hints

¹***Scene menu** Display **FORMAT** for picture formats and Home cinema and **SPEAKER** for speaker combinations on Beo4.

²***Optimise and Variation** The speaker combination or the picture format is optimised if you press **Optimise** on Beo5. On Beo4 press **GO**. With each press on **Variation** on Beo5, you select a variation of **Standard**. On Beo4 use **◀** or **▶**.

Switch mode To switch between Home cinema and TV mode on Beo4, press **LIST** until **FORMAT** is displayed then press **0**.

NOTE! If you have added only two front speakers to the TV, you will only be able to choose **Mode 1–3**. You can add up to two BeoLab subwoofers to your TV.

While you watch TV, switch between available sound types.

Change sound type or language

Switch between available sound types and languages.

Sound

Bring up sound type

Sound

Press repeatedly to select

Sound type or language Store your favourite sound type when tuning in TV channels. See p. 26.

Wake-up Timer

You can make the TV switch on automatically via the Wake-up Timer. A Wake-up Timer is a once only Timer which lasts for one hour and is disabled once it has been executed.

Enter a Wake-up Timer

Choose the source, channel number and start time.

Bring up 'TV SETUP' menu → Select 'PLAY TIMER' menu → Select 'WAKE-UP TIMER' menu → Enter and accept settings

Check or delete a Wake-up Timer

Check or delete the settings of a Wake-up Timer.

Bring up 'TV SETUP' menu → Select 'PLAY TIMER' menu → Select 'WAKE-UP TIMER' menu → Change and accept settings

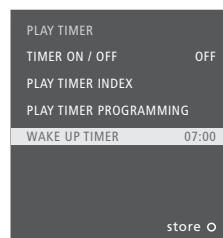

Useful hints

Wake-up Timer A Wake-up Timer applies only to the TV it has been programmed on. Make sure that the clock is set to the correct time for the Wake-up Timer to be executed correctly.

NOTE! The TV cannot be part of an ordinary Play Timer or Standby Timer until the Wake-up Timer has been carried out or disabled.

You can make your TV switch on and off automatically by setting a Play Timer or a Standby Timer in your main room system.

Timed play and timed standby

Preset your TV to start and stop automatically at the same time and day every week.

Bring up 'TV SETUP' menu and select 'PLAY TIMER' menu

→ Select 'PLAY TIMER PROGRAMMING' menu

→ Select source

→ Enter and accept settings

The source names corresponds to what the sources are registered as in the 'CONNECTIONS' menu.

- TV
- DTV
- DTV2 (V.AUX)
- V.AUX2
- V.MEM
- DVD
- DVD2
- CD
- N.MUSIC
- N.RADIO
- A.MEM
- RADIO
- DTV RADIO
- STANDBY

Switch on the Play Timer

To include the TV in the Play Timer, set the Timer to 'ON'.

Bring up 'TV SETUP' menu

→ Select 'PLAY TIMER' menu

→ Select 'TIMER ON/OFF' menu

→ Select 'ON' and accept

View, edit or delete a Timer

View, edit or delete a Timer from the list of settings you have entered.

Bring up 'TV SETUP' menu

→ Select 'PLAY TIMER INDEX' in 'PLAY TIMER' menu

→ Select Timer

→ Edit settings or delete Timer

Play Timer Enter up to six Play Timers. Make sure that the clock is set to the correct time for the Timers to be executed correctly, see p. 48. The TV cannot be part of an ordinary Play Timer or Standby Timer until the Wake-up Timer has been carried out or disabled.

Safety For safety reasons, the stand will not turn or tilt if the TV is switched on by a Play Timer.

NOTE! Link room systems can perform the timed play or timed standby functions as well. However, you must programme Timers on your main room system and activate them on your link room system.

Edit and add TV channels

Rearrange the order in which the channels appear and provide them with a name of your own choice. You can also delete a channel or add new channels, if available. Preset up to 99 TV channels on channel numbers of their own.

Move a channel

You can move TV channels to the desired channel numbers.

Bring up 'TV SETUP' menu → Select 'EDIT CHANNELS' in 'TUNING' menu → Select channel → Follow on-screen instructions

Name a channel

Name the TV channels for easy recognition.

Bring up 'TV SETUP' menu → Select 'EDIT CHANNELS' in 'TUNING' menu → Select channel →  Press → Enter and accept settings

Delete a channel

Delete channels you do not want.

Bring up 'TV SETUP' menu → Select 'EDIT CHANNELS' in 'TUNING' menu → Select channel →  Move →  Press twice to delete

Adjust tuned channels

Fine tune channel reception, indicate the presence of coded channels and choose sound types, etc.

Bring up 'TV SETUP' menu → Select 'MANUAL TUNING' in 'TUNING' menu → Select item → Follow on-screen instructions

Re-tune via automatic tuning

Re-tune all TV channels automatically. Note that all channel settings you have made will disappear.

Bring up 'TV SETUP' menu → Select 'TUNING' menu → Select 'AUTO TUNING' menu → Start auto tuning

Add new channels

Add channels which, e.g. have been moved by the broadcaster. Tune in channels via the 'ADD CHANNELS' menu, to leave previously tuned channels unchanged and keep channel names, order, and settings stored for those channels.

Bring up 'TV SETUP' menu → Select 'TUNING' menu → Select 'ADD CHANNELS' menu → Start adding channels

Useful hints

'MANUAL TUNING' The 'EXTRA' menu in the 'MANUAL TUNING' menu gives you access to the menu items 'FINE TUNE', '(DECODER)', '(TV SYSTEM)' and 'SOUND'.

'TV SYSTEM' If the item 'TV SYSTEM' appears, make sure that the correct broadcast system is displayed before you begin tuning; 'B/G' (PAL/SECAM BG), 'I' (PAL I), 'L' (SECAM L), 'M' (NTSC M) and 'D/K' (PAL/SECAM D/K). For more information, contact your retailer.

NOTE! If channels are broadcasted with two languages and you want both languages, you can store the channel twice, once with each language.

Picture and sound settings are preset from the factory to neutral values which suit most viewing and listening situations. However, if you wish, you can adjust these settings to your liking.

Adjust picture

Adjust brightness, colour and contrast. For information on picture format, see p. 22. Adjustments made to the 'TINT' setting only apply to the current channel.

Bring up 'TV SETUP' menu → Select 'OPTIONS' menu → Select 'PICTURE' menu → Enter and accept settings

Mute the picture

Remove the picture from the screen temporarily.

Bring up Scene display on Beo5 → Select Picture → Select PictureMute to mute/restore

Adjust sound

Preset volume, bass, treble or loudness, up to two connected BeoLab subwoofers and two default loudspeaker combinations. The contents of the 'SOUND' menu varies according to what you have connected to the TV. See also p. 22 about speaker combinations.

Bring up 'TV SETUP' menu → Select 'SOUND' in 'OPTIONS' menu → Select 'ADJUSTMENT' menu → Enter and accept settings

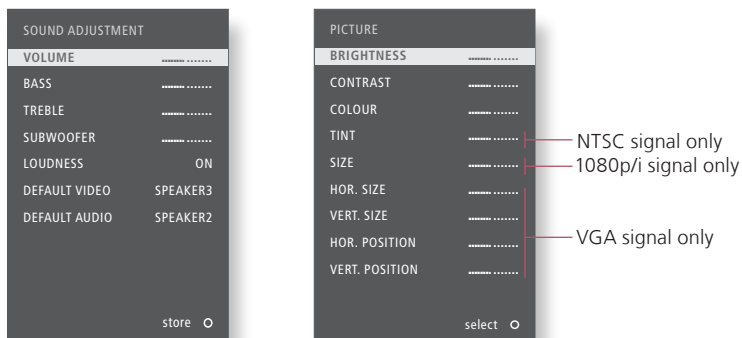

Temporary settings To only store picture and sound settings until you switch off the TV, press and hold **BACK** instead of the **centre** button when you accept the settings.

'DEFAULT VIDEO' The speaker combination chosen in the 'DEFAULT VIDEO' submenu is activated automatically when you switch on a video source in the TV.

'DEFAULT AUDIO' The speaker combination chosen in the 'DEFAULT AUDIO' submenu is activated automatically when you switch on an audio source in the TV.

The pincode system

The pincode system prevents people who do not know the pincode from using the TV. When the pincode system is activated and the TV has been disconnected from the mains for 15–30 minutes, the system goes into effect.

Activate the pincode system

Enter a four digit pincode to activate the system.

Bring up 'TV SETUP' menu



Press twice

Press

Enter a four digit code and accept

→ Re-enter the code and accept

Change the pincode

Change the pincode you have chosen.*¹

Bring up 'TV SETUP' menu

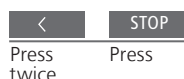

Press twice

Press

Enter pincode, accept and select 'NEW PINCODE'

→ Enter new code, accept, re-enter code and accept

Delete the pincode

Delete the pincode you have chosen.

Bring up 'TV SETUP' menu



Press twice

Press

Enter pincode and accept

→ Select 'DELETE PINCODE' and accept

Enter the pincode

If you cannot switch on the TV after disconnection from the mains, wait 30 seconds and try again.

Enter pincode

→ Accept

If you forget the pincode

Contact your Bang & Olufsen retailer to receive a five digit mastercode.

Hold when prompted for pincode to display five fields*²

Enter five digit mastercode

→ Accept to delete pincode, you can now activate pincode system again

Useful hints

¹***Change of pincode** If you change your pincode more than five times within a three-hour period, the 'PINCODE' menu becomes inaccessible for three hours, assuming that the TV is not disconnected from the mains.

Incorrect pincode Five incorrect entries will cause the TV to shut down for three hours, during which operation is not possible. Disconnecting the TV resets the three-hour period.

NOTE! If you are prompted for a pincode the first time you switch on your TV, contact your Bang & Olufsen retailer.

To cancel a pincode entry and clear the input fields, press **BACK**. On Beo4, press **STOP**.

²*On Beo4 hold **◀** to bring up the five fields.

Disable the TV or DVB tuner, if your TV or DVB source is a peripheral unit, such as a set-top box.

Disable the internal tuner

If you disable the TV tuner, you can activate a connected peripheral unit with the TV button. If you disable the DVB tuner, you can activate a connected peripheral unit with the DTV button.

Bring up 'TV SETUP' menu → Select 'TUNER SETUP' in 'OPTIONS' menu → Disable/enable 'TV TUNER' → Disable/enable 'DVB' and accept

Disable TV/DVB tuner If you disable both the TV tuner and the DVB tuner, you can activate a peripheral unit acting as tuner with either the TV button or the DTV button.

'TUNING' menu The 'TUNING' menu is only available if the TV tuner is enabled. See p. 50.

NOTE! If you have connected a Bang & Olufsen hard disc recorder to your TV, it is recommended not to disable the TV tuner.

Operate other equipment with Beo5 or Beo4

The built-in Peripheral Unit Controller acts as an interpreter between connected video equipment, such as a set-top box, recorder or DVD player, and your Bang & Olufsen remote control.

Beo5 operation

The main functions of your equipment can be operated with the Bang & Olufsen remote control. Not all functions may be supported.

→ Select source → Select function

Show menu overlay*¹

If you have a Beo4, the menu overlay gives you quick access to selected functions.

→ Select connected equipment

→ **Menu** or  → Bring up menu overlay

→ Select function

Direct Beo4 operation

Activate a function without the menu overlay. The connected equipment must be switched on.

→ Press coloured button to activate function

→   → Select channel

or

→  → Hold for Programme Guide

Useful hints

¹***Menu overlay** The menu overlay shows the options you have with a selected source. You can only bring up the menu overlay on the TV screen with a Beo4. With a Beo5 you have access to the corresponding functions via the Beo5 display. You cannot bring up the overlay in link rooms. Instead, press a desired coloured button or **GO** followed by a number.

²***Beo4** On Beo4 you have to press **GO** before the arrow buttons.

NOTE! Which source button activates your peripheral unit depends on the tuner setup and settings in the 'CONNECTIONS' menu. See pp. 29 and 37.

Use the Bang & Olufsen remote control to gain access to the functions offered by your non-Bang & Olufsen equipment.

Use equipment menus

Operate a connected equipment's own menu via the remote control. On Beo4 you may have to press **EXIT** instead of **STOP** to return to a previous menu.

Bring up equipment menu



Navigate in menus

Select function

Step in pages/
channel lists*

Enter information



Switch on or off On some connected equipment you have to press **GO** then **0** to switch the equipment on and off if you have a Beo4.

NOTE! See also the guide enclosed with the connected equipment. For further information about supported equipment, contact your Bang & Olufsen retailer.



- 
- 34 Set up your television
 - 36 Expand your setup
 - 38 Set up additional equipment
 - 40 Connection panels
 - 42 Sockets for temporary connections
 - 44 First-time setup of your television
 - 46 Loudspeaker setup
 - 48 Additional settings
 - 50 On-screen menus
 - 50 Cleaning

Set up your television

Follow the guidelines for placement and connection described on this and the following pages.

Place the TV

When you place the TV, remember that the built-in motor unit will turn the TV to a preset position when you switch it on.

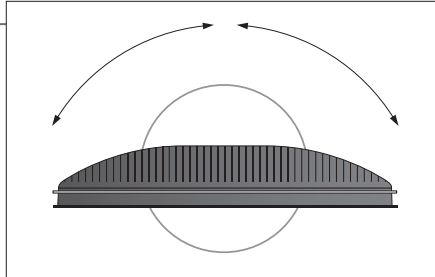

Due to the heavy weight of the TV, any moving or lifting of the TV should be performed by qualified personnel – using the proper equipment.

Ventilation

To ensure proper ventilation, allow enough space below the screen. Do not cover the fans.

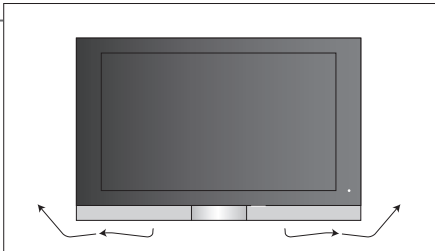

At overheating a warning will appear on the screen, switch the TV to standby, not off, in order for the TV to cool down. You cannot operate the TV during this time.

Motorised stand or wall bracket

Set the maximum angle the TV will turn. See p. 45.

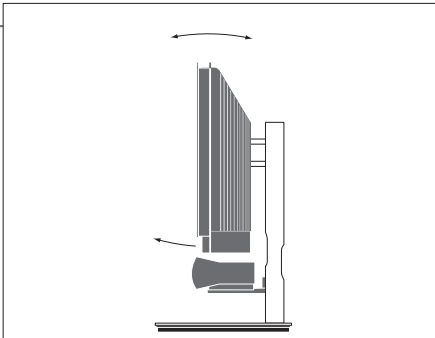

If you have a motorised stand or a wall bracket, leave enough space around the television to allow it to turn and tilt freely.

Important

Tilt/turn When you mount the television on a floor stand or wall brackets, you can tilt and turn the television on some of the stands. Only some stands can be turned and tilted with the remote control, other stands can only be tilted manually.

Placement options

The television can be placed in several ways, some are illustrated to the right.

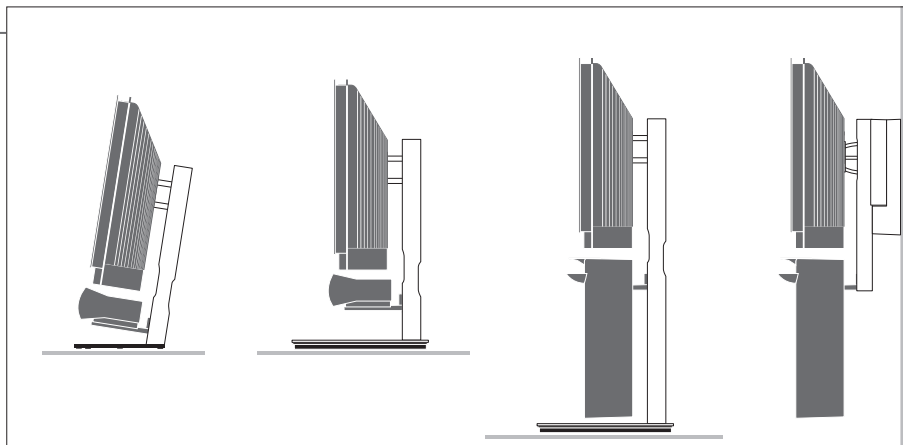

Overview

Locate the connection panels and other important items.

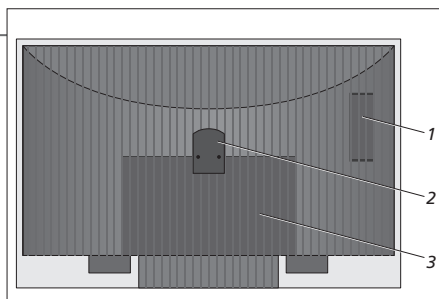

- 1 Cover for card reader (DVB-HD) and for sockets for temporary connection, such as camera and headphones sockets. Push in to open, push again to close.
- 2 Mounting bracket for stand or wall bracket.
- 3 Covers for the connection panel. Here you also find the mains supply connection. Pull out at the bottom to remove.

Expand your setup

Your TV supports a wide range of additional equipment. You can even connect a projector or a home automation system to control room lights and curtains. Connect video recorders only to AV1 or AV2.

Disconnect from the mains

While expanding your setup, the TV must be disconnected from the mains.

→ Switch off TV → Disconnect TV from mains

Connect additional equipment

To operate non-Bang & Olufsen products with Beo5, attach a Bang & Olufsen IR-transmitter to each product. See also p. 38.

→ Select corresponding socket marked PUC → Make the connections

Switch on the TV

Always attach covers before you connect the TV to the mains.

→ Attach all covers → Connect TV to mains supply → Switch on TV

Information

'AUTO SELECTION'	Automatic selection of connected sources, when the TV is on and detects a signal.
'TIMER RECORDER'	Activate the Timer recording option for a connected recorder. Only available in the 'AV1' and 'AV2' menus, and can only be activated in one of these menus at any time.
'HDMI'	Equipment connected via an HDMI IN socket. If you have set the 'HDMI EXPANDER' in the 'CONNECTIONS' menu to 'YES', the 'HDMI-C' option in the 'AV' menus is replaced with 'HDMI-C1', 'HDMI-C2', 'HDMI-C3', and 'HDMI-C4'.

Register additional equipment

Register the equipment you have connected to the TV, if it is not detected automatically by the TV. Repeat the procedure for each socket group.

Bring up 'TV SETUP' menu → Select 'CONNECTIONS' in 'OPTIONS' menu → Select sockets in a socket group and register → Select 'STANDBY OPTIONS' menu → Follow on-screen instructions

Contents of the 'CONNECTIONS' menu

AV1–AV6
DISPLAY 2
HDMI EXPANDER
LINK

Register connected equipment
Register a connected projector
Enable or disable an HDMI Expander connected to the HDMI C socket
Set a link frequency and enable the system modulator

Source options in the 'AV1–AV6' menus

NONE
TV
DTV
DTV2 (V.AUX)
V.MEM
DVD
DVD2
PC
V.AUX2
CENTRE

Nothing connected
Connected TV tuner
Equipment, such as a set-top box
Equipment, such as a set-top box
Connected video recorder
Optional Blu-ray player
Connected DVD player or recorder
Connected PC
Equipment, such as a video game console
For connection of a source centre, which may contain up to six built-in sources (only in the 'AV1–AV2' menus)

The above are only examples of registrations, you can register additional equipment to any available source option. You may also have to register additional equipment in the Master Link system.

'(VGA)' Equipment connected via VGA socket (AV5 or AV6).
'(Y – Pb – Pr)' Equipment connected via Y – Pb – Pr socket (AV2 or AV3).
'STANDBY OPTIONS' Set the set-top box to switch off when you switch source or when you switch off the TV. You can also choose that the set-top box should always be switched on or that it should be switched on and off manually by means of the remote control.

Set up additional equipment

Set up the TV with video sources and loudspeakers.

Video signals

Connect your video signals, such as a cable, antenna, or satellite to the sockets shown on the diagram to the right.

Loudspeakers

Use Bang & Olufsen Power Link speakers. Use the cables enclosed with the speakers. Longer cables are available from your Bang & Olufsen retailer.

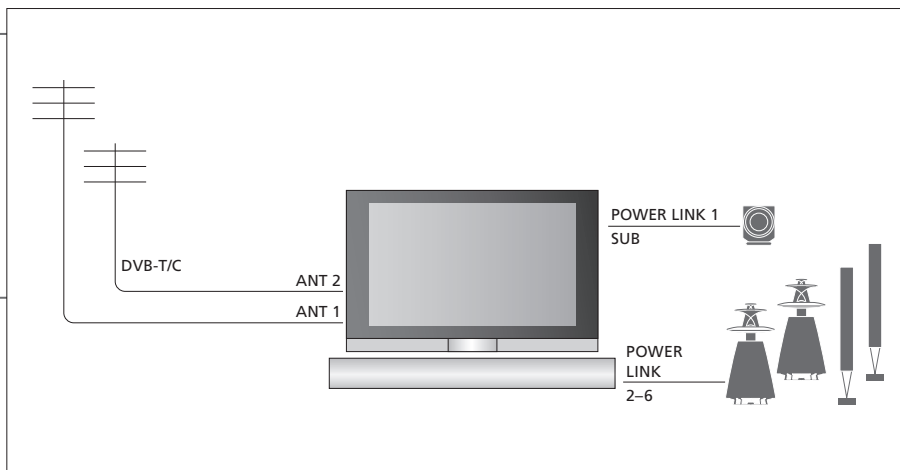

Additional video equipment

Connect many different types of video equipment at the same time. Here you can also see examples of source names you can select for the equipment in the 'CONNECTIONS' menu.

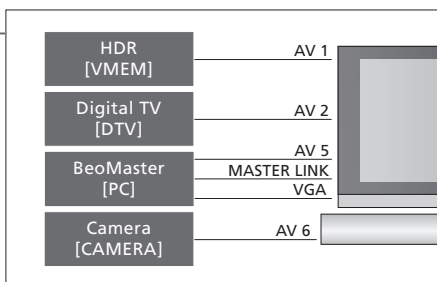

IR-transmitters: To operate non-Bang & Olufsen products with a Bang & Olufsen remote control, attach a Bang & Olufsen IR-transmitter to each of the products. Connect each transmitter to the corresponding socket marked PUC on the main connection panel.

Useful hints

Equipment with HDMI output

Equipment with HDMI output can be connected to any available HDMI socket, regardless of the particular AV socket group to which you have connected the equipment. For more information about how to set up connected equipment for use, see p. 37.

Expand your setup, for example in a home cinema system with a projector and a home automation system.

Home cinema setup

Use a projector or connect a home automation system to the TV, so you can control room lights and curtains.

IR-receiver

If the built-in IR-receiver for the remote control signals is hidden behind a lowered projector screen, you must set up an external IR-receiver as well.

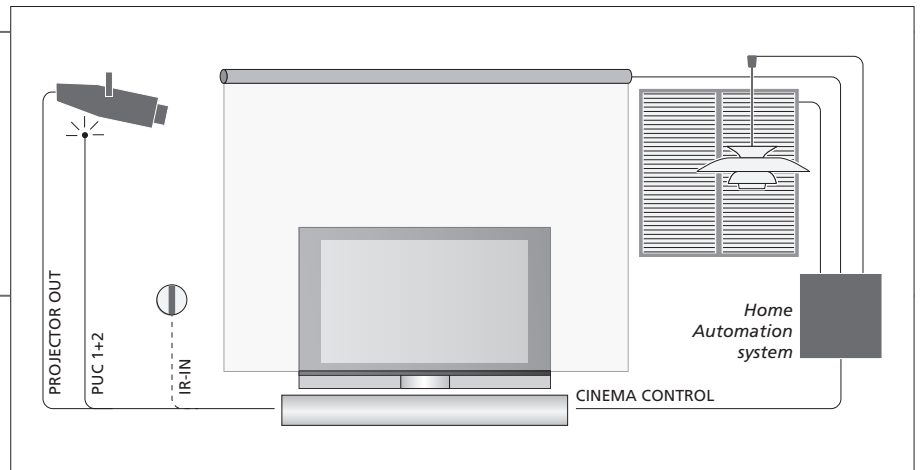

Audio system

Connect a Bang & Olufsen audio system with a Master Link socket to your TV. Connect it to the Master Link socket on the main connection panel. See also pp. 14–15.

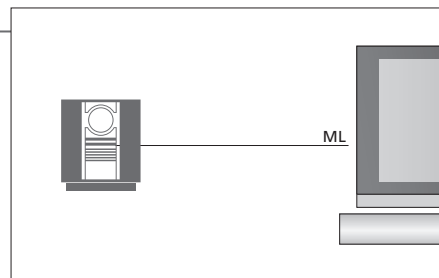

Mains cord and plug

The supplied mains cord and plug are specially designed for the TV. If you change the plug or in any way damage the mains cord, it can affect the TV performance. Connect the ~ socket on the main connection panel of your TV to the wall outlet. The IR-receiver lights up in red and the TV is in standby mode and ready to be used.

Connection panels

Any equipment you connect to the main connection panel must be registered in the 'CONNECTIONS' menu. See p. 44.

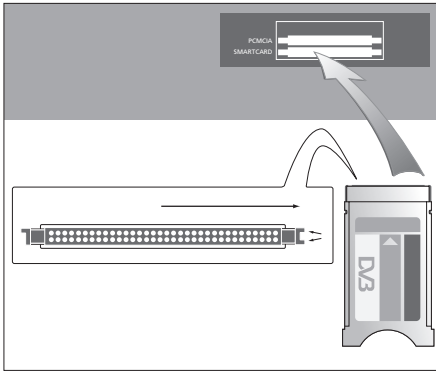

The CA module has one protruding edge on one side and two on the other side. The side with two edges should face right. When you insert a card, the gold chip should face upwards.

PCMCIA/ SMARTCARD

For a card and module for access to digital satellite channels. For further information about compatible card and module combinations, contact your Bang & Olufsen retailer.

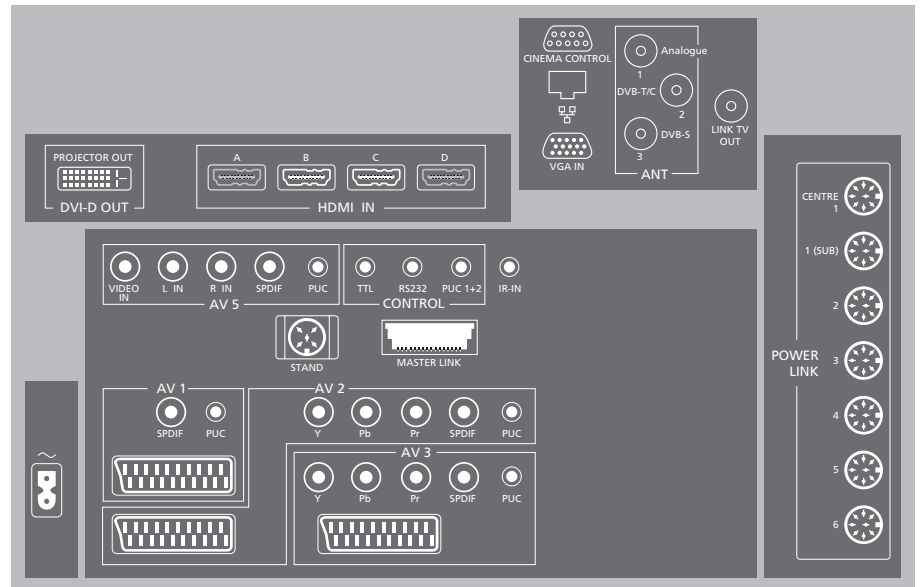

PROJECTOR OUT (DVI-D OUT)

Connect a projector.

HDMI IN (A–D)

For High Definition Multimedia Interface video source or PC. The sources can be registered to any of the AV socket groups. Connect an HDMI Expander to the HDMI C socket.

AV 1

Socket for AV connection of a primary recorder or set-top box. You can also connect other types of extra video equipment.

AV 2

Socket group for AV connection of additional video equipment.

Useful hints

HDMI source You can watch two HDMI sources at the same time if one of the sources is connected to the HDMI A or HDMI B socket, and the other source is connected to the HDMI C or HDMI D socket.

“Greyed out” sockets on the illustration of the main connection panel may be occupied by internal connections. Do not disconnect the cables from these sockets!

AV3

Socket group for AV connection of additional video equipment.

The TV keeps a signal path open between a recorder connected to the AV1 socket and a recordable source connected to the AV3 socket. This allows you to set the source on AV3 to switch on automatically, as well as set a recorder on AV1 for timed recording of the source on AV3, provided your connected equipment supports these functions.

AV4

Occupied by the optional Blu-ray

AV5

Socket group for AV connection of additional video equipment.

PUC (AV1 – AV3, AV5)

For IR control signals to external equipment connected to an AV socket.

L-IN, R-IN (AV5)

Right and left line input.

VIDEO IN (AV5)

For video signal.

Y – Pb – Pr (AV2–AV3)

For video signals from an external source, e.g. HDTV source. You can use the socket in conjunction with an AV socket or a digital audio socket.

SPDIF (AV1 – AV3, AV5)

Digital audio input socket, e.g. DVD player.

TTL/RS232

Only for use in Hotel setups.

PUC 1+2

For an external IR-transmitter used with Home cinema setups.

IR IN

For an extra IR-receiver when the TV is set up with a projector.

STAND

For connection of a motorised stand.

MASTER LINK

For a compatible Bang & Olufsen audio or video system. The socket is also used for BeoLink distribution of sound and picture throughout the house.

CINEMA CONTROL

For a Home Automation system.

(Ethernet)*¹

For connection to the Internet.

VGA IN

Socket for connection of a High Definition video source or a PC.

ANT (1–3)

Aerial input sockets 1 (analogue), 2 (DVB T/C), 3 (DVB S) from external aerial/cable TV network.

LINK TV OUT

Aerial output for distribution of video signals to other rooms.

CENTRE 1

For connection of a centre speaker, e.g. BeoLab 7. For further information, see the speaker’s own Guide.

POWER LINK 1–6

For connection of external speakers in a surround sound setup.

1 (SUB)

For connection of up to two Bang & Olufsen subwoofers. A cable splitter for such connections is available from your Bang & Olufsen retailer.

~ – Mains supply

Connection to the mains supply.

NOTE! Video recorders can only be connected to the AV1 and AV2 socket groups, as these are the only sockets groups for video output. Connect the primary recorder to AV1 and the secondary recorder to AV2.

¹*NOTE! Only connect to a local area network (LAN) that does not exit your flat, house or building.

Sockets for temporary connections

Connect headphones and listen to a TV programme, connect a camera or PC and see the pictures on the screen, or connect a Camcorder and watch or record your home movies.

Make temporary connections

To always activate these sockets, register the connected equipment in the 'CONNECTIONS' menu.

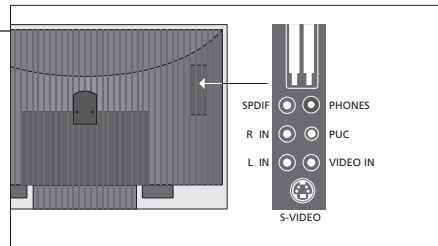

SPDIF
Digital audio input socket.

PHONES
For connection of stereo headphones.

L-IN – R-IN
For audio connection (left and right sound channel respectively) of, e.g. a camera or camcorder.

PUC
For IR control signals to external equipment.

VIDEO IN
For connection of the video signal of a camera or camcorder.

S-VIDEO
For the connection of, e.g. a game console.

The USB port (→) is for service use only.

Connect a computer to the TV

Disconnect the TV, the computer and all equipment connected to the computer from the mains. Make the connections and reconnect to the mains.

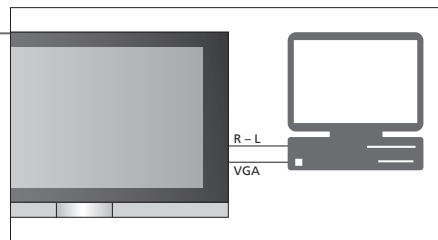

Connect the cable to the VGA/HDMI socket on the TV. To hear sound in connected speakers connect the sound output on the computer to the R-L sockets on the TV.

Useful hints

Headphones To mute speakers turn the volume wheel quickly counter-clockwise. Turn the volume wheel either way to adjust volume in headphones. To restore sound in speakers, turn the volume wheel quickly counter-clockwise.

Bring up computer picture Press the source button for the computer to bring up a picture on the TV.



First-time setup of your television

This first-time setup procedure is activated when the TV is connected to the mains and switched on for the first time. If you want to change your setup at a later date, you can access the same menus and update your settings.

Switch on the TV

TV

It takes the TV approx. 20 seconds to start up and become ready for use.

Switch on

Make settings

< >

GO

You are led through the following settings only when you switch on the TV for the first time.*¹

Select setting

Accept and go to next menu item

MENU LANGUAGE

Set the on-screen menu language

TUNER SETUP

Disable or enable internal TV tuner or DVB

CONNECTIONS

Register connected equipment, see p. 37

AUTO TUNING

Tune in TV channels automatically, see also p. 26. Available only if the TV tuner is enabled, see p. 29.

Calibrate the speakers

Set up the speakers to optimise sound from your listening position.

SPEAKER TYPES

First-time setup of loudspeakers applies only to speakers for TV viewing. After first-time setup, you can set up speakers for Home cinema viewing. See also '*Loudspeaker setup*' on pp. 46–47 and '*Surround sound and Home cinema*' on p. 22.

SPEAKER ROLES

SPEAKER DISTANCE

SPEAKER LEVEL

SOUND ADJUSTMENT

Adjust volume, bass, treble and loudness and preset two default speaker combinations. Select a different speaker combination at any time. See p. 27.

Information

- Menu language** Select the language for on-screen menus.
- TV tuner** The 'TUNING' menu is only available if the TV tuner is enabled, see pp. 29 and 50.
- Connections** Select the type of equipment connected to each socket, the sockets used, the product name, and the source name.
- Auto tuning** A menu for channel tuning automatically appears on the screen.

¹*NOTE! When you have made the preferred settings in a menu, you may have to press the green button to continue to the next menu in the first-time setup procedure. Follow on-screen instructions.

When first-time setup is complete, you can then set up your loudspeakers for Home cinema use.

Calibrate the stand

The motorised movement of the TV will not work until the calibration process has been completed.

STAND ADJUSTMENT



At 'SET LEFTMOST POSITION' turn left to the point you wish to restrict the movement to



At 'SET RIGHTMOST POSITION' turn right to the point you wish to restrict the movement to



At 'SET TOP POSITION' tilt up to the point you wish to restrict the movement to



At 'SET BOTTOM POSITION' tilt down to the point you wish to restrict the movement to



Accept*¹

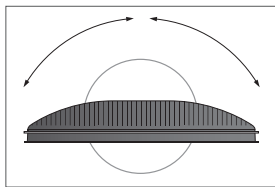

STAND POSITIONS

Set preferred preset position for the TV to turn to, when it is switched on and off. See p. 48.

Stand adjustment Set the maximum angle the TV will turn – left and right.

NOTE! You need to calibrate the stand before you can use the motorised movement of the stand.

Loudspeaker setup

Add Power Link speakers and up to two BeoLab subwoofers to your TV and you have a surround sound system.

Select speaker setup

Switch on the TV in TV or Home cinema mode before you adjust speaker settings for either mode.

Switch on TV and bring up 'TV SETUP' menu → Select 'SOUND' in 'OPTIONS' menu → Select menu

Set speaker type

Register the type of each speaker in the menu. Each Bang & Olufsen speaker makes a sound and is highlighted on the screen.

Select 'SPEAKER TYPES' menu → Select speaker and reveal speaker type → **GO** → Accept

Set speaker role

Select the function for each connected loudspeaker, such as front, back or surround. A speaker can have more than one role – one for TV viewing and one for Home cinema viewing.

Select 'SPEAKER ROLES' menu → Reveal speaker role for each speaker → **GO** → Accept

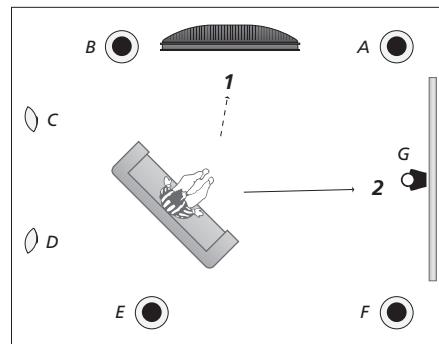

Set speaker role.

TV (1)	Home cinema (2)
A: Right front	Left front
B: Left front	Left surround
C: Off	Left back
D: Off	Right back
E: Left back	Right surround
F: Right back	Right front
G: Off	Centre

Information

Sound during setup During the setup process, a sound is sometimes produced by a speaker. Check if the highlighted speaker matches the name of the speaker making the sound.

Speaker roles You must select the surround speakers before you can select the back speakers.

NOTE! To make a Home cinema setup, you must first switch to Home cinema mode. For information about Home cinema, see p. 22

If your setup includes two different viewing positions, a Home cinema setup and a regular TV viewing setup, you must make two different loudspeaker settings.

Set speaker distance

Enter the straight-line distances in metres between your favourite viewing position and the individual speakers.

Select 'SPEAKER DISTANCE' menu

→ Select speaker and select distance

→  Accept

Calibrate the sound level

A calibration sound is produced alternately in each speaker. Adjust the speakers to match the centre speaker's sound level.

Select 'SPEAKER LEVEL' menu

→ Select 'AUTOMATIC' or 'MANUAL' in 'SEQUENCE'

→ If 'MANUAL' is selected, select speaker and adjust level

→  Accept

See active sound system

See the name of the active sound system for a source or programme on the screen.

Bring up 'TV SETUP' menu

→ Select 'SOUND' in 'OPTIONS' menu

→ Select 'SOUND SYSTEM' menu

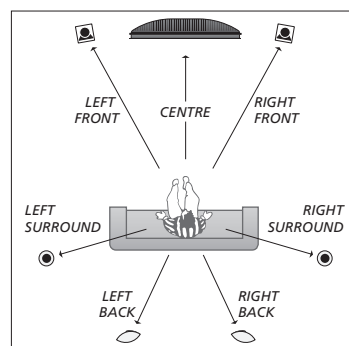

Set speaker distance.

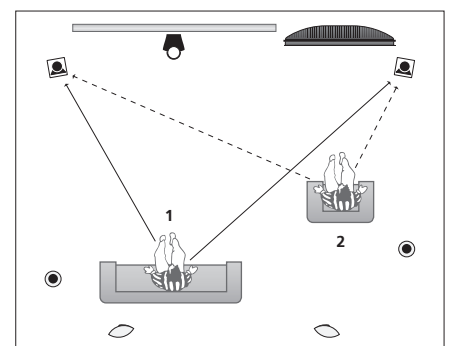

Calibrate sound level from two different viewing positions.

Speaker sound level Calibrate each speaker in reference to the centre speaker to ensure an optimal surround sound.

NOTE! Once you have performed the speaker calibration, you will only need to re-calibrate the speaker sound if you make changes to the setup.

Additional settings

You have the possibility to make additional settings, such as to set the positions for the TV to turn to, to set the correct time and date, and to make settings for the optional Blu-ray player.

Positions of the TV

Programme a position for when you watch TV, listen to music, and when the TV is switched off. See p. 45 about first-time installation of the stand.

Bring up 'TV SETUP' menu and select 'STAND POSITIONS' menu

Select 'VIDEO', 'AUDIO' or 'STANDBY'

Turn/tilt TV as desired

Accept*¹

Time and date

Set the time and date. Press **Clock** on Beo5 to bring up the clock on the display. It disappears again after 10 seconds.

Bring up 'TV SETUP' menu and select 'OPTIONS' menu

Select 'CLOCK' menu

Set time and date

Accept

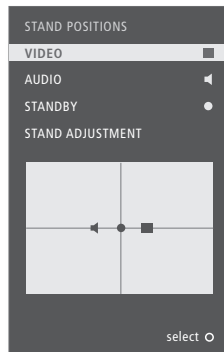

Information

- ¹***First-time setup** During first-time setup, when you have set the TV positions, press the green button to continue first-time setup.
- Optional stand** If your television is equipped with an optional motorised stand, you can preset positions.

NOTE! The simplest way to set the clock is to synchronise it with the teletext service offered by the current TV channel via the 'CLOCK' menu. If a teletext service is not available, you can set the clock manually.

Disable the parental lock

Enable or disable the parental lock function on the optional Blu-ray player. Remember to remove the disc first.

Press **DVD** and then press **Menu** twice to bring up the 'TV SETUP' menu

→ Move to 'OPTIONS' and press **Menu** to reveal the 'PARENTAL LOCK'

→ Press the **centre** button to bring up the menu. Press again to disable the parental lock

→ Press **STOP** to leave without disabling the parental lock or press **BACK** to leave all menus

Settings for the Blu-ray player

The 'SETUP' menu offers options for settings and adjustments for the optional Blu-ray player

Press 'DVD setup' to bring up 'SETUP' menu

→ Select a setting

Contents of the 'SETUP' menu

PLAYBACK STATUS

Select between 'STANDARD' or 'EXTENDED'. 'EXTENDED' gives access to 'BONUS VIEW' and 'ANGLE'

AUDIO FORMAT

Decode audio formats to PCM/DTS or send in original format

LANGUAGE

Select audio/subtitle language or language on disc menu

ACCESS CONTROL

Enter a parental lock, rating or a new access code

ADVANCED

Format the memory, make network settings, see information about software versions and if connected to the Internet, update the Blu-ray player

Access control

When you enter the 'ACCESS CONTROL' menu you are asked to enter and confirm your access code. The first time you enter the menu, you are asked to select a new access code.

General settings: Select your Zone, TV and Menu.

1. < > GO

TUNING*¹

PLAY TIMER

OPTIONS

STAND POSITIONS

2. < > GO

EDIT CHANNELS p.26

ADD CHANNELS p.26

AUTO TUNING p.26

MANUAL TUNING

TIMER ON/OFF p.25

PLAY TIMER INDEX p.25

PLAY TIMER PROGRAMMING p.25

WAKE-UP TIMER p.24

CONNECTIONS

TUNER SETUP

SOUND

PICTURE p.27

CLOCK p.48

MENU LANGUAGE p.44

VIDEO p.48

AUDIO p.48

STANDBY p.48

STAND ADJUSTMENT p.45

3. Make settings GO

MANUAL TUNING (EXTRA) p.26

AV1–AV6 p.37

DISPLAY 2 p.37

HDMI EXPANDER p.37

LINK p.37

TV TUNER*¹ p.29

DVB p.29

SOUND ADJUSTMENT p.27

SPEAKER TYPES p.46

SPEAKER ROLES p.46

SPEAKER DISTANCE p.47

SPEAKER LEVEL p.47

SOUND SYSTEM p.47

Cleaning

Maintenance Screen	Regular maintenance, such as cleaning, is the responsibility of the user. Use a soft, dry cloth to wipe dust off the screen. Do not use liquid cleaners or aerosol cleaners.
Cabinet and controls	Wipe dust off the surfaces using a dry, soft cloth. To remove stains or dirt, use a soft, damp cloth and a solution of water and mild detergent, such as washing-up liquid.
Never alcohol	Never use alcohol or other solvents to clean any parts of the TV.

Blu-ray settings: Select your Zone, DVD and DVD setup.

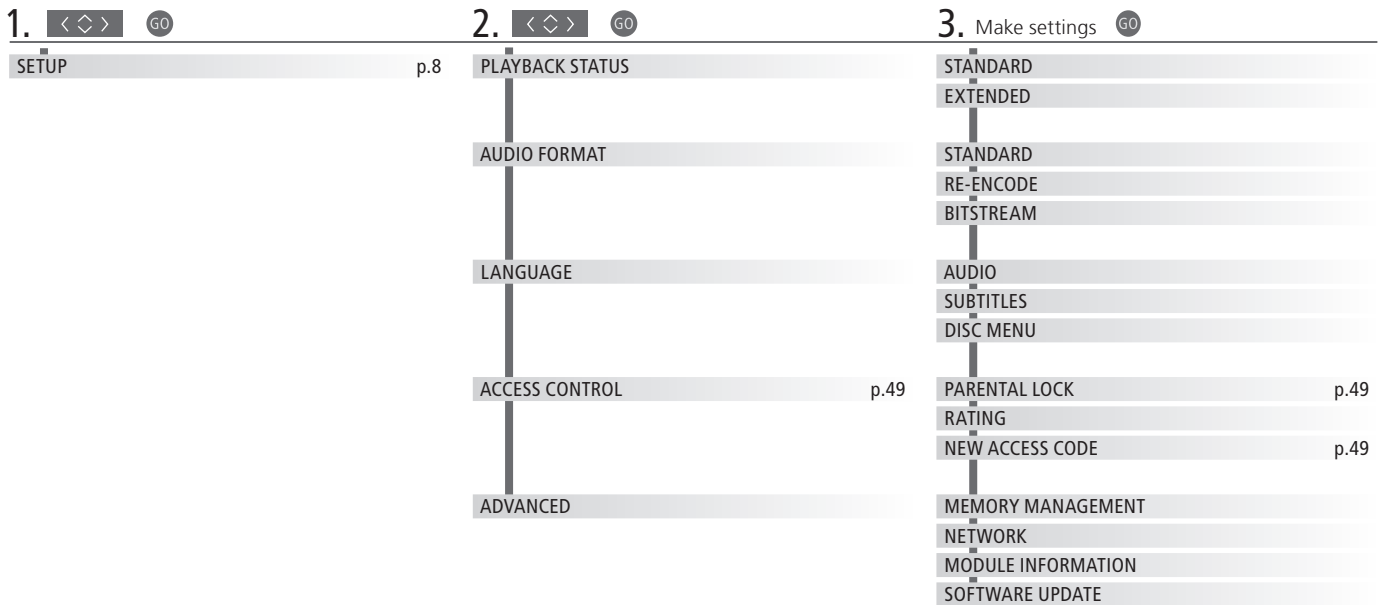

¹*NOTE! The 'TUNING' menu is only available if the TV tuner is enabled in the 'TUNER SETUP' menu.

Waste Electrical and Electronic Equipment (WEEE) – Environmental protection



Electrical and electronic equipment, parts and batteries marked with this symbol must not be disposed of with normal household wastage; all electrical and electronic equipment, parts and batteries must be collected and disposed of separately.

When disposing of electrical and electronic equipment and batteries by use of the collection systems available in your country, you protect the environment, human health and contribute to the prudent and rational use of natural resources.

Collecting electrical and electronic equipment, batteries and waste prevents the potential contamination of nature with the hazardous substances which may be present in electrical and electronic products and equipment.

Your Bang & Olufsen retailer will advise you of the correct way of disposal in your country.

If a product is too small to be marked with the symbol, it will appear in the User Guide, on the Guarantee certificate, or on the packaging.



This product is in conformity with the provisions of the Directives 2004/108/EC and 2006/95/EC.



The DVD Video logo is a registered trademark.



"Blu-ray Disc" and the Blu-ray Disc logo are registered trademarks.

BONUS VIEW™ "BONUSVIEW™" is a registered trademark of Blu-ray Disc Association.



Java Technology – a registered trademark of Sun Microsystems.

Manufactured under license from Dolby Laboratories. Dolby, Pro Logic, and the double-D symbol are registered trademarks of Dolby Laboratories.

Confidential unpublished works.
Copyright 1992–2003 Dolby Laboratories.
All rights reserved.

Manufactured under license under U.S. Patent #'s: 5,451,942; 5,956,674; 5,974,380; 5,978,762; 6,487,535; 7,003,467; 7,212,872 & other U.S. and worldwide patents issued & pending.

DTS, DTS Digital Surround, ES, and Neo:6 are registered trademarks and the DTS logos, and Symbol are trademarks of DTS, Inc.

© 1996–2008 DTS, Inc.
All Rights Reserved.

This product incorporates copyright protection technology that is protected by U.S. patents and other intellectual property rights. Use of this copyright protection technology must be authorized by Macrovision, and is intended for home and other limited viewing uses only unless otherwise authorized by Macrovision. Reverse engineering or disassembly is prohibited.

HDMI, the HDMI logo and High-Definition Multimedia Interface are trademarks or registered trademarks of HDMI Licensing LLC.

**CLASS 1
LASER PRODUCT**

The label on the compact disc player serves as a warning that the apparatus contains a laser system and is classified as a class 1 laser product. In case any difficulties arise with the compact disc player, please contact a Bang & Olufsen retailer. The apparatus must be opened by qualified service personnel only.

CAUTION: The use of any controls, adjustments or procedures other than those specified herein may result in hazardous radiation exposure. The use of optical instruments with this product will increase eye hazard. As the laser beam used in this CD/DVD Player is harmful to eyes, do not attempt to disassemble the cabinet. Refer servicing to qualified personnel only. Laser radiation when open. Do not stare into beam. This label is located on the rear enclosure.

